

SHOWBEAM



SHOWBEAM™ 2.5

User Manual

©High End Systems, Inc. 2009, All Rights Reserved

Information and specifications in this document are subject to change without notice. High End Systems, Inc. assumes no responsibility or liability for any errors or inaccuracies that may appear in this manual.

Trademarks used in this text:

High End Systems, WholeHog, and Lithopatterns are registered trademarks; and SHOWBEAM, Internal Effects, the High End Systems globe logo, Light Burst, the Wholehog logo are trademarks of High End Systems, Inc. or High End Systems Europe Ltd. Hog is a registered trademark of Flying Pig Systems. Belden is a registered trademark of Belden, Inc. FastFit is a trademark and Philips is a registered trademark of Philips Lighting Company. Krytox is a registered trademark of DuPont.

Other trademarks and trade names may be used in this document to refer to either the entities claiming the marks and names or their products. High End Systems disclaims any proprietary interest in trademarks and trade names owned by others.

HIGH END SYSTEMS®



SHOWBEAM™ 2.5 User Manual

Version 1.0

June, 2009

Contacting High End Systems®

U.S. and the Americas

Sales Department

High End Systems, Inc.
2105 Gracy Farms Lane
Austin, TX 78758 USA
voice: 512.836.2242
fax: 512.837.5290
Toll Free: 800.890.8989

Customer Service

High End Systems, Inc.
2105 Gracy Farms Lane
Austin, TX 78758 USA
voice: 800.890.8989
fax: 512.834.9195
toll free: 800.890.8989

World Wide Web:

<http://www.highend.com>

Declaration of Conformity

according to ISO/IEC Guide 22 and EN45104

Manufacturer's name:High End Systems, Inc.

Manufacturer's address:2105 Gracy Farms Lane
Austin, Texas 78758 USA

Distributor's name:High End Systems, Inc.

Distributor's address:2105 Gracy Farms Lane
Austin, Texas 78758 USA

Declares that the product

Product Name:SHOWBEAM 2.5

Product Number:All

Product Options:All

conforms to the following EEC directives:

73/23/EEC, as amended by 93/68/EEC

89/336/EEC, as amended by 92/31/EEC and 93/68/EEC

Equipment referred to in this declaration of conformity was first manufactured in compliance with the following standards in 2005:

Safety:EN 60598-1: 1997

EN 60598-2-17; 1990

A1-A3: 1998

A13: 1999

EMC:

EN 55022

Conducted Emissions Class A

Radiated Emissions Class A

ANSI C63.4 Class A

FCC 47 CFR Part 15 Class A

VCCI V-1/2001.04 Class A

EN 55024

EN 61000-4-2 4/8kV

EN 61000-4-3 A1 3V/m

EN 61000-4-4 1kV/0.5kV

EN 61000-4-5 2kV/1kV

EN 61000-4-6 3 Vrms

EN 61000-4-11 >95%-0.5p, 30%-25p,>95%-250p

EN 61000-3-2 Class A

EN 61000-3-3



USA, Wednesday, November 03, 2010

Kenneth Stuart Hansen, Compliance Engineer

Product Modification Warning

High End Systems products are designed and manufactured to meet the requirements of United States and International safety regulations. Modifications to the product could affect safety and render the product non-compliant to relevant safety standards.

Mise En Garde Contre La Modification Du Produit

Les produits High End Systems sont conçus et fabriqués conformément aux exigences des règlements internationaux de sécurité. Toute modification du produit peut entraîner sa non conformité aux normes de sécurité en vigueur.

Produktmodifikationswarnung

Design und Herstellung von High End Systems entsprechen den Anforderungen der U.S. Amerikanischen und internationalen Sicherheitsvorschriften. Abänderungen dieses Produktes können dessen Sicherheit beeinträchtigen und unter Umständen gegen die diesbezüglichen Sicherheitsnormen verstoßen.

Avvertenza Sulla Modifica Del Prodotto

I prodotti di High End Systems sono stati progettati e fabbricati per soddisfare i requisiti delle normative di sicurezza statunitensi ed internazionali. Qualsiasi modifica al prodotto potrebbe pregiudicare la sicurezza e rendere il prodotto non conforme agli standard di sicurezza pertinenti.

Advertencia De Modificación Del Producto

Los productos de High End Systems están diseñados y fabricados para cumplir los requisitos de las reglamentaciones de seguridad de los Estados Unidos e internacionales. Las modificaciones al producto podrían afectar la seguridad y dejar al producto fuera de conformidad con las normas de seguridad relevantes.

Important Safety Information

Instructions pertaining to continued protection against fire, electric shock, and injury to persons are found in Appendix B. Please read all instructions prior to assembling, mounting, and operating this equipment.

Important: Informations De Sécurité

Les instructions se rapportant à la protection permanente contre les incendies, l'électrocution, excessif et aux blessures corporelles se trouvent dans l'Annexe B. Veuillez lire toutes les instructions avant d'assembler, de monter ou d'utiliser cet équipement.

Wichtige Sicherheitshinweise

Sicherheitsanleitungen zum Schutz gegen Feuer, elektrischen Schlag, und Verletzung von Personen finden Sie in Anhang B. Vor der Montage, dem Zusammenbau und der Inbetriebnahme dieses Geräts alle Anleitungen sorgfältig durchlesen.

Informazioni Importanti Di Sicurezza

Le istruzioni sulla protezione da incendi, folgorazione, e infortuni sono contenute nell'appendice B. Si prega di leggere tutte le istruzioni prima di assemblare, montare e azionare l'apparecchiatura.

Informacion Importante De Seguridad

En el Apéndice B se encuentran instrucciones sobre protección continua contra incendios, descarga eléctrica, y lesiones personales. Lea, por favor, todas las instrucciones antes del ensamblaje, montaje y operación de este equipo.

FCC Information

This equipment has been tested and found to comply with the limits for a Class A digital device, pursuant to part 15 of the FCC rules. These limits are designed to provide reasonable protection against harmful interference when the equipment is operated in a commercial environment. This equipment generates, uses, and can radiate radio frequency energy and, if not installed and used in accordance with the instruction manual, may cause harmful interference to radio communications. Operation of this equipment in a residential area is likely to cause harmful interference, in which case the user will be required to correct the interference at his own expense.

Safety Symbols

The following international caution and warning symbols appear in margins throughout this manual to highlight messages.



This symbol appears adjacent to Caution messages. Not heeding these messages could result in personal injury and/or damage to equipment.



This symbol appears adjacent to high voltage warning messages. Not heeding these messages could result in serious personal injury.



This symbol indicates the minimum focus distance from a combustible object.



This symbol cautions against mounting the fixture on or near a flammable surface.



This symbol indicates an explosion hazard.



This symbol cautions against an Ultraviolet Radiation hazard.



This symbol indicates that eye protection should be worn to prevent potential injury.



This symbol warns of a fire hazard.



This symbol indicates that, while operating, equipment surfaces may reach very high temperatures. Allow the fixture to cool before handling.

Warranty Information

Limited Warranty

Unless otherwise stated, your product is covered by a one year parts and labor limited warranty. Dichroic filters and LithoPatterns® are not guaranteed against breakage or scratches to coating. It is the owner's responsibility to furnish receipts or invoices for verification of purchase, date, and dealer or distributor. If purchase date cannot be provided, date of manufacture will be used to determine warranty period.

Returning an Item Under Warranty for Repair

It is necessary to obtain a Return Material Authorization (RMA) number from your dealer or point of purchase BEFORE any units are returned for repair. The manufacturer will make the final determination as to whether or not the unit is covered by warranty. Lamps are covered by the lamp manufacturer's warranty.

SHOWBEAM 2.5 fixtures must be returned in their original roadcases. Any other parts returned to High End Systems must be packaged in a suitable manner to ensure the protection of such Product unit or parts, and such package shall be clearly and prominently marked to indicate that the package contains returned Product units or parts and with an RMA number. Accompany all returned Product units or parts with a written explanation of the alleged problem or malfunction. Ship returned Product units or parts to: 2105 Gracy Farms Lane, Austin, TX 78758 USA.

Note: *Freight Damage Claims are invalid for fixtures shipped in non-factory boxes and packing materials.*

Freight

All shipping will be paid by the purchaser. Items under warranty shall have return shipping paid by the manufacturer only in the Continental United States. Under no circumstances will freight collect shipments be accepted. Prepaid shipping does not include rush expediting such as air freight. Air freight can be sent customer collect in the Continental United States.

REPAIR OR REPLACEMENT AS PROVIDED FOR UNDER THIS WARRANTY IS THE EXCLUSIVE REMEDY OF THE CONSUMER. HIGH END SYSTEMS, INC. MAKES NO WARRANTIES, EXPRESS OR IMPLIED, WITH RESPECT TO ANY PRODUCT, AND HIGH END SPECIFICALLY DISCLAIMS ANY WARRANTY OF MERCHANTABILITY OR FITNESS FOR A PARTICULAR PURPOSE. HIGH END SHALL NOT BE LIABLE FOR ANY INDIRECT, INCIDENTAL OR CONSEQUENTIAL DAMAGE, INCLUDING LOST PROFITS, SUSTAINED OR INCURRED IN CONNECTION WITH ANY PRODUCT OR CAUSED BY PRODUCT DEFECTS OR THE PARTIAL OR TOTAL FAILURE OF ANY PRODUCT REGARDLESS OF THE FORM OF ACTION, WHETHER IN CONTRACT, TORT (INCLUDING NEGLIGENCE), STRICT LIABILITY OR OTHERWISE, AND WHETHER OR NOT SUCH DAMAGE WAS FORESEEN OR UNFORESEEN.

Warranty is void if the product is misused, damaged, modified in any way, or for unauthorized repairs or parts. This warranty gives you specific legal rights, and you may also have other rights which vary from state to state.

Patents

This product may use one or more of the following patents: US 4,392,187; US 4,602,321; US 4,688,161; US 4,701,833; US 4,709,311; US 4,779,176; US 4,800,474; US 4,962,687; US 4,972,306; US 4,980,806; US 5,010,459; US 5,031,078; US 5,073,847; US 5,078,039; US 5,186,536; US 5,209,560; US 5,278,742; US 5,282,121; US 5,307,295; US 5,329,431; US 5,331,822; US 5,367,444; US 5,402,326; US 5,414,328; US 5,426,576; US 5,430,629; US 5,432,691; US 5,454,477; US 5,455,748; US 5,502,627; US 5,506,762; US 5,515,254; US 5,537,303; US 5,545,951; US 5,588,021; US 5,590,954; US 5,590,955; US 5,640,061; US 5,647,662; US 5,691,886; US 5,702,082; US 5,728,994; US 5,758,955; US 5,758,956; US 5,769,527; US 5,769,531; US 5,774,273; US 5,788,365; US 5,794,881; US 5,795,058; US 5,798,619; US 5,806,951; US 5,812,596; US 5,823,661; US 5,825,548; US 5,828,485; US 5,829,868; US 5,857,768; US 5,882,107; US 5,921,659; US 5,934,794; US 5,940,204; US 5,945,786; US 5,953,151; US 5,953,152; US 5,969,485; US 5,980,066; US 5,983,280; US 5,984,248; US 5,986,201; US 6,011,662; US 6,029,122; US 6,048,080; US 6,048,081; US 6,054,816; US 6,057,958; US 6,062,706; US 6,079,853; US 6,126,288; US 6,142,652; US 6,142,653; US 6,172,822; US 6,175,771; US 6,188,933; US 6,208,087; US 6,219,093; US 6,220,730; US 6,241,366; US 6,249,091; US 6,255,787; US 6,256,136; US 6,261,636; US 6,278,542; US 6,278,545; US 6,278,563; US 6,288,828; US 6,326,741; US 6,327,103; US 6,331,756; US 6,346,783; US 6,421,165; US 6,430,934; US 6,459,217; US 6,466,357; US 6,502,961; US 6,515,435; US 6,523,353; US 6,536,922; US 6,538,797; US 6,545,586; US 6,549,324; US 6,549,326; US 6,563,520; US 6,565,941; US 6,570,348; US 6,575,577; US 6,578,991; US 6,588,944; US 6,592,480; US 6,597,132; US 6,600,270; US 6,601,974; US 6,605,907; US 6,617,792; US 6,621,239; US 6,622,053; US 6,635,999; US 6,648,286; US 6,664,745; US 6,682,031; US 6,693,392; US 6,696,101; US 6,719,433; US 6,736,528; US 6,771,411; US 6,775,991; US 6,783,251; US 6,801,353; US 6,812,653; US 6,823,119; US 6,865,008; US 6,866,390; US 6,866,402; US 6,866,451; US 6,869,193; US 6,891,656; US 6,894,443; US 6,919,916; US 6,930,456; US 6,934,071; US 6,937,338; US 6,955,435; US 6,969,960; US 6,971,764; US 6,982,529; US 6,988,805; US 6,988,807; US 6,988,817; US 7,000,417; US 7,011,429; US 7,018,047; US 7,020,370; US 7,033,028; US 7,048,838; US 7,055,963; US 7,055,964; US 7,057,797; US 7,073,910; US 7,078,869; US 7,092,098; US 7,119,902; US 7,161,562; US 7,175,317; US 7,181,112; US 7,206,023; US 7,210,798; US D347,113; US D350,408; US D359,574; US D360,404; US D365,165; US D366,712; US D370,080; US D372,550; US D374,439; US D377,338; US D381,740; US D409,771; AT E169413; CA 2142619; CA 2145508; CA 2245842; DE 22588.4-08; DE 621495; DE 655144; DE 69320175.4; DE 69322401.0; DE 69331145.2; DE 69525856.7; DE 69734744.3; DE 797503; DK 0655144; DK 1447702; EP 0475082; EP 0621495; EP 0655144; EP 0662275; EP 0767398; EP 0797503; EP 0969247; EP 1447702; ES 0621495; FR 0621495; FR 0655144; FR 0662275; FR 1447702; GB 2043769B; GB 2055842B; GB 2283808B; GB 2290134B; GB 2291814B; GB 2292530B; GB 2292896B; GB 2294909B; GB 2295058B; GB 2303203B; GB 2306887B; GB 2307036B; GB 2316477B; IE 0621495; IT 034244BE; 2005; IT 0621495; IT 0655144; JP 3495373; JP 3793577; NL 0621495; NL 0797503; NL 0969247; UK 0621495; UK 0655144; UK 0662275; UK 0797503; UK 0969247; UK 1447702;



Table of Contents

SHOWBEAM™ 2.5	i
User Manual	i
Contacting High End Systems®	ii
Declaration of Conformity	iii
Product Modification Warning	iv
Important Safety Information	iv
FCC Information	v
Safety Symbols	v
Warranty Information	vi
Limited Warranty	vi
Returning an Item Under Warranty for Repair	vi
Freight	vi
Patents.....	vii
Table of Contents	ix

Chapter 1: Product Overview

SHOWBEAM™ 2.5 Features	1
Features	1
Operation	2
Construction	2
Related Products and Accessories	2
SHOWBEAM™ 2.5 Specifications	3
Mechanical	3
Operational	4
Environmental	4
Electrical	4
Power.....	4
Fuses	4
Lamp Specifications	5
DMX/RDM Cable and Connector Specifications	5
Fixed Color Specifications	5

Chapter 2: Setup and Configuration

Unpacking the Fixture	7
Pan and Tilt Locking	7
Installing a Power Cord Cap	8
Installing a Line Cord Cap - U.K. Only	8
Vatic Fitter Heads Information - Danmark	8

Mounting the Fixture	9
Mounting the Fixture Upright	9
Truss Mounting	10
Linking SHOWBEAM 2.5 Fixtures	11
Cable Connectors	11
Connecting to the Link	12
Powering On the Fixture	12
Setting the DMX Start Channel	13
Shutting Down the Fixture	14
Placing Fixture in Road Case	14

Chapter 3: Menu System

Navigating the Menu System	15
The SHOWBEAM 2.5™ Display	15
Navigational Basics	16
Display in Menu Locked Mode	16
Fixture Software Version	16
DMX Start Channel	16
Error Message Display.....	16
Unlocking the Menu System	17
Exiting the Menu System	17
Menu Map	17
Menu System Options	20
DMX Address Menu	20
Setting DMX Start Channel	20
Determining DMX Start Channel Assignment	20
Set Parameters Menu	22
Factory Default Settings.....	22
Pan/Tilt Swap	22
Pan Invert	23
Tilt Invert.....	23
Lamp Life Limit	24
Data Loss Timeout.....	24
Test Options Menu	25
Homing the Fixture.....	25
Lamp State.....	25
Copying the Boot Code.....	25
Motor Setup	25

Information Menu	26
Sensor Status Menu	26
Unique Number.....	26
DMX Values Menu	26
Temperatures Menu	27
Fixture Hours	27
Fixture Hours Reset.....	28
Lamp Hours	28
Lamp Strikes	28
Lamp HR/Strike Reset	28
Lamp Status.....	28
Software Version	28
Display Errors.....	29
Next DMX Channel	29

Chapter 4: Fixture Programming

DMX Programming Overview	31
Full Speed verses MSPEED Control	31
DMX Programming Options	31
Programming with a DMX Console	31
SHOWBEAM 2.5 DMX Parameters	32
Pan and Tilt	32
Color Control	33
Color Flags	33
CMY Color Mixing	33
Tri Color Effect	33
CTO	33
Static Color Wheel	34
Zoom	34
Zoom Bypass	35
Twin Beam Effect	35
Twin Beam Parameter	35
Twin Beam Deviation Parameter	35
Twin Beam Rotation	36
LED Tracking System	37
LED Tracking Functions	37
LED Tracking System Dimming	37
Dim Tracking Mode	37
Tracking System Independent Dim Mode.....	37

Shutter and Lamp Effects	38
MSpeed (Motor Speed)	39
Macros	39
Control Settings	40
Chapter 5: Maintenance and Troubleshooting	
Fixture Component Replacement	42
Replacing Fuses	42
Locating Fuses	42
Replacement Fuses.....	42
Replacing the Lamp	43
Cleaning SHOWBEAM 2.5 Fixtures	45
Lens	45
Reflector	45
Filter	46
Production Homing	47
Accessing the Bulk Heads	47
Flag Calibration Example	48
Calibrate the flags	49
Troubleshooting	50
Power Supply	50
System State LEDs	51
Board LED States	51
SHOWBEAM 2.5 Board LEDs	51
Appendix A: MSpeed Conversion Table.....	53
Appendix B: Important Safety Information	55
Appendice B: Importantes Informations Sur La Sécurité	57
Anhang B: Wichtige Hinweise Für Ihre Sicherheit	58
Apéndice B: Información Importante De Seguridad	59
Appendice B: Importanti Informazioni Di Sicurezza	60
Vigtig Sikkerhedsinformation	61

Chapter I:

Product Overview

The SHOWBEAM™ 2.5 fixture is a new dedicated automated wash luminaire with featuring a Twin Beam™ effect that produces two discrete hard-edge beams. You have variable control over the Twin Beam's deviation and rotation speed with minimal brightness degradation and can vary the Twin Beam by adding incremental color using the CMY color mixing system.

The SHOWBEAM 2.5 features a jointly developed Philips MSR 2500-watt lamp source. A smooth field, soft-edge illumination is produced using a lenticular homogenizing lens system. In addition, SHOWBEAM includes a user changeable fixed color wheel, a variable CTO, a full CMY color mixing system, and the ability to produce an 11-degree fixed hard-edge profile with fast color change and Electronic Strobe. The profile can be rapidly zoomed from 11 to 33 degrees.

SHOWBEAM 2.5 also includes the LED tracking system encircling the lens that can be used alone or as a complementary ring of color.

SHOWBEAM™ 2.5 Features

Features

- Proprietary Short Arc Lamp and optics produce 140,000 center lumens of light
- 2500W wash light
- Electronic strobe
- Full optical dimming and fade to black
- Innovative Twin Beam effect
- Quick zoom range from 11° - 42°
- Zoom Bypass creates 11° hard edge
- Smooth CMY color mixing provides and infinite color palette
- Variable CTO color temperature correction
- TriColor effect supports independent color flag control
- Fixed color wheel provides 3 colors plus open
- Innovative LED Tracking Ring produces over 5000 lumens of RGB color. Homogenously mixed RGB LED circular array eliminates the multiple colored RGB look when white or mixed colors are produced.
- Tracking and Independent LED control modes selectable via DMX
- Optical encoders automatically correct the head's position if manually moved

Operation

- 420° pan and 216° tilt movement
- Auto-switching power supply
- 200v-240v
- 32 DMX channels
- DMX/RDM Connector: 5-pin XLR
- Compliances: ETL, CE

Construction

- Modular construction
- Fast service design for Reflector, Condenser and Output lens
- Electronic cooling system control
- Stunningly fast, smooth and quiet yoke movement using proprietary multi-phase technology
- Performance oriented exterior design prevents stray light scatter
- Pan and tilt locks for easy transportation.

Related Products and Accessories

The following table lists other products you can utilize with the SHOWBEAM fixture and optional accessories available from your High End Systems dealer/distributor.

Part Description	Part Number
Replacement Lamp (7000 K)	55030087
Wholehog [®] 3 Lighting Console	25020001
Road Hog [®] Full Boar	
Road Hog [®] Lighting Console	A2020001
Heavy duty 5-pin XLR cable (10')	55050017
Heavy duty 5-pin XLR cable (25')	55050018
Heavy duty 5-pin XLR cable (50')	55050019
Heavy duty 5-pin XLR cable (100')	55050020
Upload Dongle	26040002
Galvanized safety cable	12040001
Mega-Claw clamp	67040007
Diffusion cleaning applicator	90901001

For more information about optional accessories, contact either your High End Systems[®] dealer/distributor, High End Systems Sales, or visit the High End Systems Web site. For contact information, see *Contacting High End Systems[®]* on page ii.

SHOWBEAM™ 2.5 Specifications

Mechanical

Fixture Dimensions: 596mm x 605mm x 925mm (23.5in x 23.8in x 36.4in)

Road Case Dimensions: 749mm x 1200mm x 724mm (29.5in x 47.25in x 28.5in)

Fixture Weight: 66.2kg (146 lb)

Shipping Weight (Roadcase + fixture): 120 kg (266 lb)

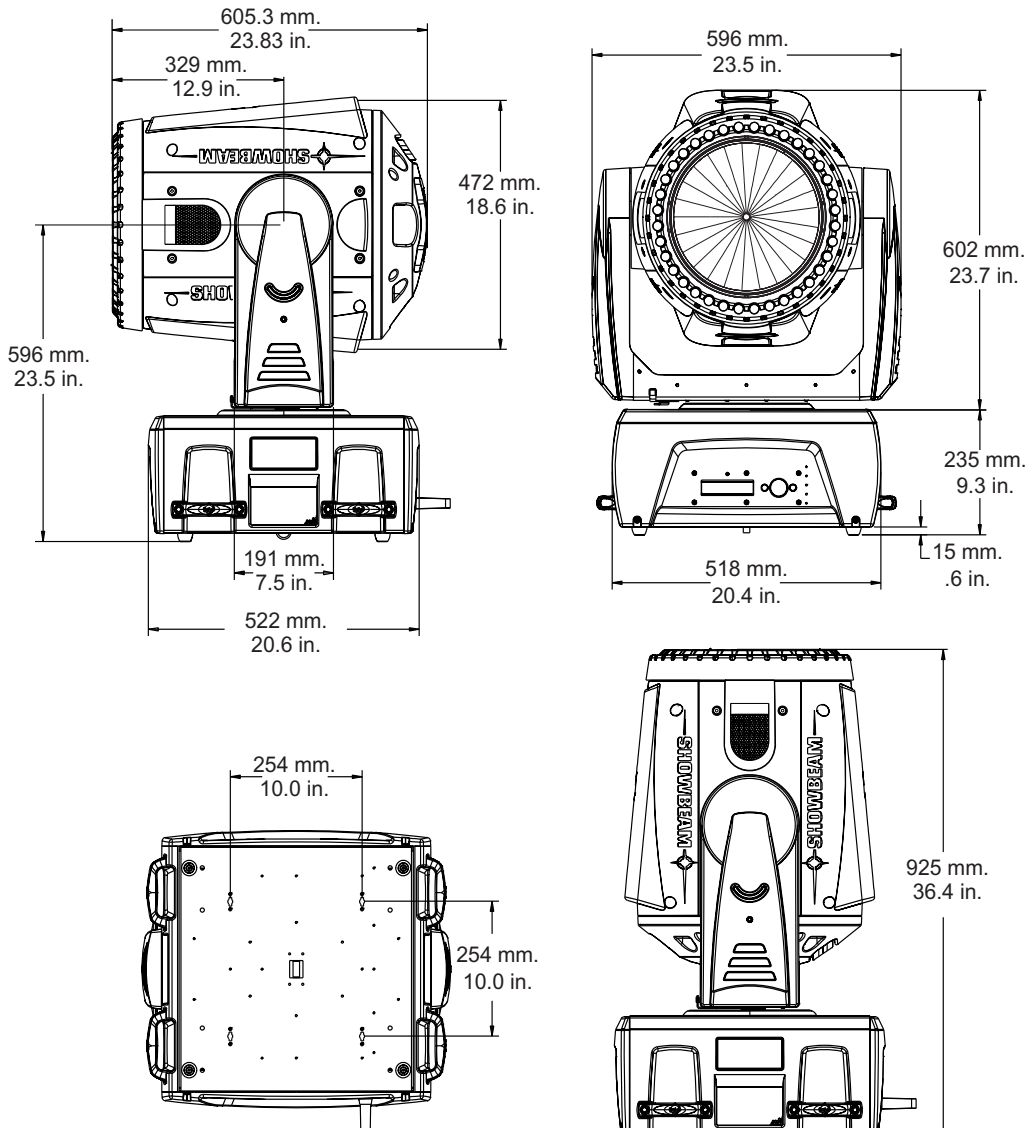

Operational

Pan: 420°

Tilt: 216°

Zoom Range: 11°–33°

Fixture Output: 140,000 Lumens (3 point: center, middle, and edge)

Environmental

Maximum ambient temperature, (T_a): 45° C (113° F)

Minimum Projection Distance to Flammable Objects: 6 m (19.7 ft)

Maximum exterior surface temperature: 150° C (302° F)

Minimum Focus Distance to *non-flammable* object: 3 m (10 ft)

Electrical

Power

Input Rating: 200-240 VAC

Fixture Rated Power: 2800 W

Power Consumption: 18 Amps at 200 V, 15 Amps at 240V



WARNING!

Class 1 equipment - This equipment must be earthed.

FUSES

Fuse	Fuse Type and Rating	Manufacturer	Part Number
Motor Power Supply Input	2.5A, 250V, Slow Blow	Littelfuse	90403027EF
Motor Power Supply Output	5A 250V, Slow Blow	Littelfuse	90403012EF
2-phase Driver Boards	2.5A, 125V, Slow Blow SMF	Littelfuse	90402016EF
3-phase Pan and Tilt Board			
LED Control Board	5A, 125V, Slow Blow SMF	Littelfuse	90412027EF
Lamp Power Supply Input	20A, 250V, Very Fast	Bussmann	90403030EF

Lamp Specifications

Lamp: PHILIPS MSR 2500/2

Power: 2500 W

Color Temperature: 7000K

Barco rated Lamp Life: 1250 hrs

CRI: >80

CIE: X=.320; Y=.330

DMX/RDM Cable and Connector Specifications

Data cables: Belden[®] 9841 or equivalent (meets specifications for EIA RS-485 applications) with the following characteristics:

- 2-conductor twisted pair plus a shield
- maximum capacitance between conductors - 30 pF/ft.
- maximum capacitance between conductor and shield - 55 pF/ft.
- maximum resistance of 20Ω / 1000 ft.
- nominal impedance 100-140 Ω

Data connectors: 5-pin male and female XLR connectors

Data terminators: Male XLR connector with 120 ohm terminator

Fixed Color Specifications

Diameter : 64.9 mm \pm .20 mm (2.56 in \pm .008 in)

Clear Aperture: 53.34 mm \pm .25 mm (2.1 in \pm .01 in)

Concentricity of Clear Aperture: \pm .18 mm (.007 in)

Maximum Thickness: 2.80 mm (.17in)

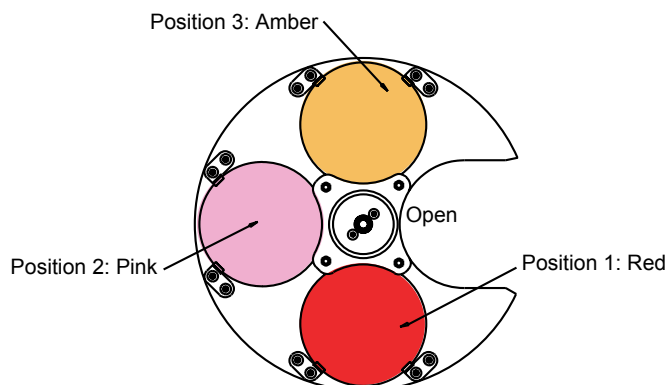

Chapter 2:

Setup and Configuration

SHOWBEAM™ 2.5 fixture setup includes mounting, connecting to power and DMX linking and configuration.

Use the following steps to set up and configure your SHOWBEAM 2.5™ fixture:

- 1. Unpack the fixture.**
- 2. Install power cord cap for your location.**
- 3. Mount the fixture upright or suspended from a standard truss.**
- 4. Connect the fixture to a DMX controller via DMX cabling.**
- 5. Connect the fixture to power.**
- 6. Configure the fixture for DMX control.**

Unpacking the Fixture

The SHOWBEAM™ 2.5 fixture ships in a road case specifically designed to protect the product during transport. When unpacking, inspect the fixture for physical damage to components. High End Systems® assumes no responsibility for products that are damaged during transport. Return a product for repair in its road case.

Before sending anything to the factory, call your High End Systems dealer/distributor for a Return Material Authorization (RMA) number. The factory cannot accept any goods shipped without an RMA number.

Pan and Tilt Locking

The SHOWBEAM 2.5 fixture ships with pan and tilt latches locked. You can unlock/adjust these latches to stabilize the fixture for mounting.

Note: *Disengage Pan and Tilt locks before operating the fixture.*

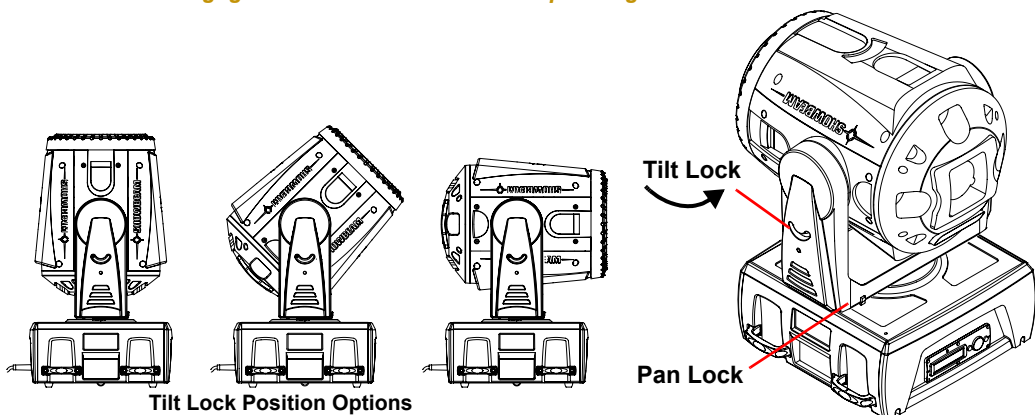

Installing a Power Cord Cap

The custom power cord for SHOWBEAM 2.5 fixtures ships without a power cord cap. Use the information in this section to install the correct power cord cap for your location.

Because of the variety of power cord caps used worldwide, High End Systems, Inc. cannot make specific recommendations for the power cord cap. Contact a local authority for the type of power cord cap needed. When installing the power cord cap, note that the cores in the mains lead are colored according to the following code:

- green and yellow = earth
- blue = neutral
- brown = live

Installing a Line Cord Cap - U.K. Only

In the United Kingdom, core colours in the mains lead of this equipment may not correspond with the colored markings identifying the terminals in the fixture's plug. In that case, install a line cord cap in accordance with the following code:

- Connect the green and yellow core to the plug terminal marked with the letter "E," or by the earth symbol  or coloured green, or green and yellow.
- Connect the blue core to the terminal marked with the letter "N" or coloured black.
- Connect the brown core to the terminal marked with the letter "L" or coloured red.



WARNING:
Class 1 equipment - This equipment must be earthed.

Vatic Fitter Heads Information - Danmark

Advarsel: Beskyttelse mod elektrisk chock.

Vigtigt!

Lederne med gul/groen isolation maa kun tilsluttes en klemme maerket



eller



Mounting the Fixture

You can mount your SHOWBEAM 2.5 fixture suspended from a support system (such as a truss) or freestanding on its base.



WARNING!

Equipment suitable for dry locations only. Do not expose this equipment to rain or moisture.



CAUTION!

SHOWBEAM 2.5 fixtures must be installed and operated by trained personnel only.

Always use a secondary safety cable when mounting this fixture.



Do not mount on a flammable surface or within 1 m (3 ft) of a flammable object.



Maintain a minimum focus distance of 4 m (13.1 ft) from any flammable object.



Maintain a minimum focus distance to *non-flammable* lighted object of 3 m (9.8 ft)

Note: Due to the wide variety of possible lighting designs, High End Systems cannot make specific mounting recommendations. Consider the following procedure as a suggested guideline only.

Mounting the Fixture Upright



CAUTION!

Do not mount the fixture upright without the four rubber feet attached.

To mount the fixture upright:

1. Place the fixture on a sturdy, stable non-flammable surface that will support more than the 63.5 kg (140 lb) weight of the SHOWBEAM 2.5 fixture. If the surface is above floor height, use safety cables to secure the fixture to the surface.
2. Disengage Pan and Tilt locks before powering up the fixture.

Truss Mounting

When mounting the fixture on a truss or another type of support:

- Verify the truss or support will handle the combined weight of all the devices on the truss.
- Always mount a SHOWBEAM 2.5 fixture using the mounting bracket assembly that shipped with your fixture and a safety cable attached to the fixture's base.



WARNING!

Before mounting, disconnect power to the fixture. If it has been operating, allow the fixture to cool for five minutes before handling.



CAUTION!

Do not use C- Clamps to mount the SHOWBEAM 2.5 fixture to a truss.

Only experienced lighting personnel should attempt to hang a lighting fixture to an appropriate theatrical truss.

WARNING!

In all cases, a safety cable should also be fixed between the safety cable mounting point located at the bottom of the fixture base housing and the truss. Failure to use a safety cable could result in injury or death. High End Systems supplies the proper safety cables and may be contacted for replacements if necessary. For more information go to: www.highend.com/trusshang.

Use the following steps to mount a SHOWBEAM 2.5 fixture on a standard truss:

1. Due to its size and weight, at least two people should support the fixture while another attaches clamps and safety cables. Always stand on a firm, stable surface when mounting the fixture to its support.
2. Tighten the clamps firmly to the fixture's base and to the truss.
3. Run the safety cable through the loop on the fixture's base, and around the truss.
4. Disengage Pan and Tilt locks before powering up the fixture.

Linking SHOWBEAM 2.5 Fixtures

SHOWBEAM 2.5 fixtures operate on standard DMX512 link controlled by a DMX console. The number of fixtures on a link will be determined by the combined number of channels required by all the fixtures. A SHOWBEAM 2.5 fixture requires a 32 channel footprint on a standard DMX512 link.

Attach the fixture to the link using data-grade cable and 5-pin XLR cable connectors.

Cable Connectors

The SHOWBEAM 2.5 fixture accepts 5-pin XLR cable connectors. Cabling must have a male XLR connector on one end of the cable and a female XLR connector on the other end.

Pin one is the common (cable shield), pin two is the data complement (negative), pin three is the data true (positive). Pins four and five are not used, but they allow a secondary data link to pass through the fixture.

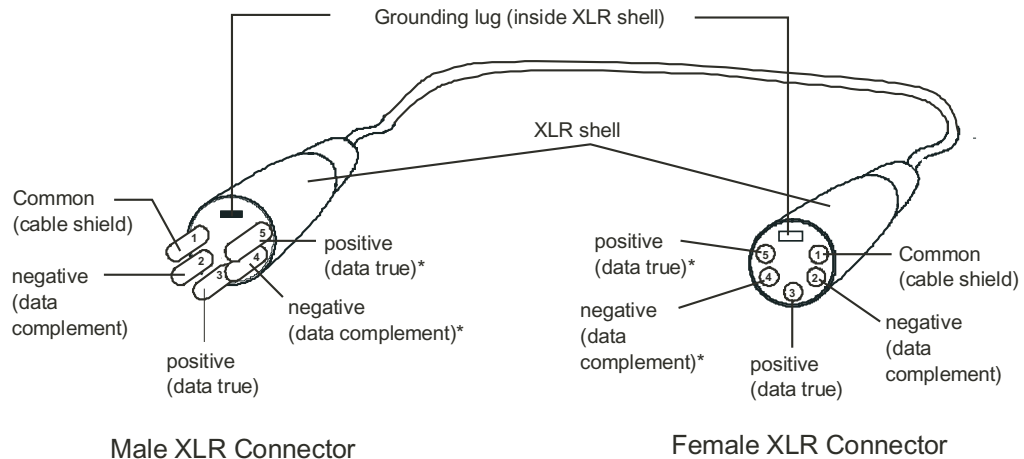

**This data line is not used by the fixture, but allows data to pass through the fixture.*

Test each cable with a voltage/ohm meter (VOM) to verify correct polarity and to make sure that the negative and positive pins are not grounded or shorted to the shield or to each other.



CAUTION!

Do not connect anything to the ground lug on the XLR connectors. Do not connect or allow contact between the common (cable shield) and the fixture's chassis ground. Grounding the common could cause a ground loop and/or erratic behavior.

Connecting to the Link

To link one or more fixtures to a DMX controller:

1. Connect the male XLR connector of a DMX Data cable to the controller's DMX Data Out connector.
2. Connect the Data cable's female XLR connector to the Data In connector of the first (or next) fixture on the DMX link.
3. Continue linking the remaining fixtures connecting a cable from the Data Out connector of each fixture to the Data In connector of the next fixture on the link.
4. Terminate the link by installing a 120 ohm, 1/4 watt (minimum) terminator in the fixture's Data Out (female) cable connector in the last fixture on each DMX link. A terminator on the last fixture of the link prevents data reflection, which can corrupt the data communication on the link.

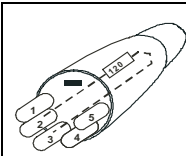

To construct a terminator:

1. Disassemble a male 5-pin XLR connector.
2. Solder a 120 ohm resistor, minimum of 1/4 watt, between Pin 2 and Pin 3.
3. Reassemble the XLR connector.

Powering On the Fixture



WARNING:

This equipment is designed for connection to a branch circuit having a maximum overload protection of 20 A.



CAUTION:

Do not power on the fixture until *verifying* that the line cord cap is suitable for the power source in your location. For more information, see *Installing a Power Cord Cap* on page 8.

Disengage Pan and Tilt locks before operating the fixture. For more information, see *Pan and Tilt Locking* on page 7.

Do not unplug motor harnesses while unit is powered.

To power on the SHOWBEAM 2.5 fixture, simply connect it to a 200V-240V AC power source.

Once the SHOWBEAM 2.5 fixture is connected to a power source, it automatically begins a homing procedure to verify that fixture components are functioning.

Setting the DMX Start Channel

Each SHOWBEAM 2.5 fixture requires a block of 32 consecutive channels on a 512-Channel DMX link. Up to 16 standard SHOWBEAM 2.5 fixtures can be assigned to a single 512-Channel DMX link. For more information on Start Channels, see *Determining DMX Start Channel Assignment* on page 20.

To Set the Start Channel on a SHOWBEAM 2.5 fixture:

1. Access the fixture's menu system via the dot matrix display on the fixture's front panel. For a detailed description of the menu system, see *Chapter 3: Menu System* on page 15.

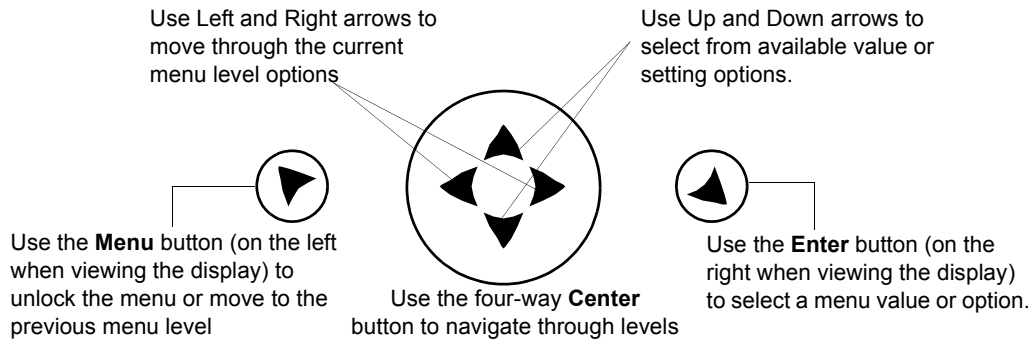

Note: *Navigation system buttons' functions invert automatically when the fixture is turned upside down.*

2. Unlock the menu system by pressing and holding down the **Menu** button until the extended 2-line display appears. `DMX ADDRESS MENU` is the first option at the top menu level.
3. Press the **Enter** button to select. The display will show `SET DMX START CHANNEL###`. The display will show the start channel currently assigned to the fixture.
4. Use the Up and Down arrow buttons on the **Center** button to select a new DMX start channel. The display will flash a new option ready for selection.

Note: *The last valid Start channel for a SHOWBEAM 2.5 fixture is based on its 32-channel range. The last valid start channel for a SHOWBEAM 2.5 fixture is 481 (512–32+1).*

5. Press the **Enter** button to store the new DMX Start channel. The display will stop flashing when a new option is entered.

Shutting Down the Fixture

A DMX controller can shut down the fixture remotely with the Shutdown option in the Control Channel or you can simply disconnect from power. The SHOWBEAM 2.5 fixture automatically shuts down in the event of DMX data loss longer than five minutes.

Placing Fixture in Road Case

Before shipping a SHOWBEAM 2.5 fixture, lock the pan and tilt position so the fixture does not move during transit.

To lock the fixture:

1. Orient the projector head pan position as shown for packing in the road case and secure with the pan lock located on the yoke base.

Note: *This is the only pan position that locks.*

2. Move the tilt lock peg to the upper left (locked) position.
3. Gently move the projector head and yoke to verify that both pan and tilt positions are locked in place.

4. Place a SHOWBEAM 2.5 fixture in the road case as shown for shipping.

Note: *Each roadcase has labels for orienting the fixture.*

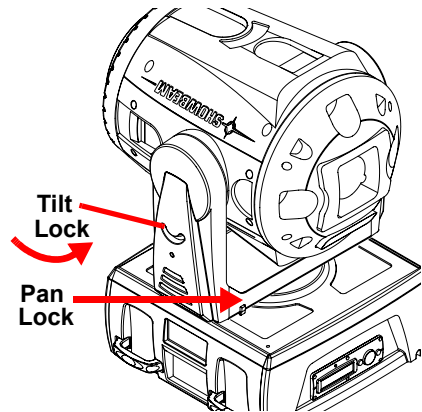

1. Place Top over the fixture first

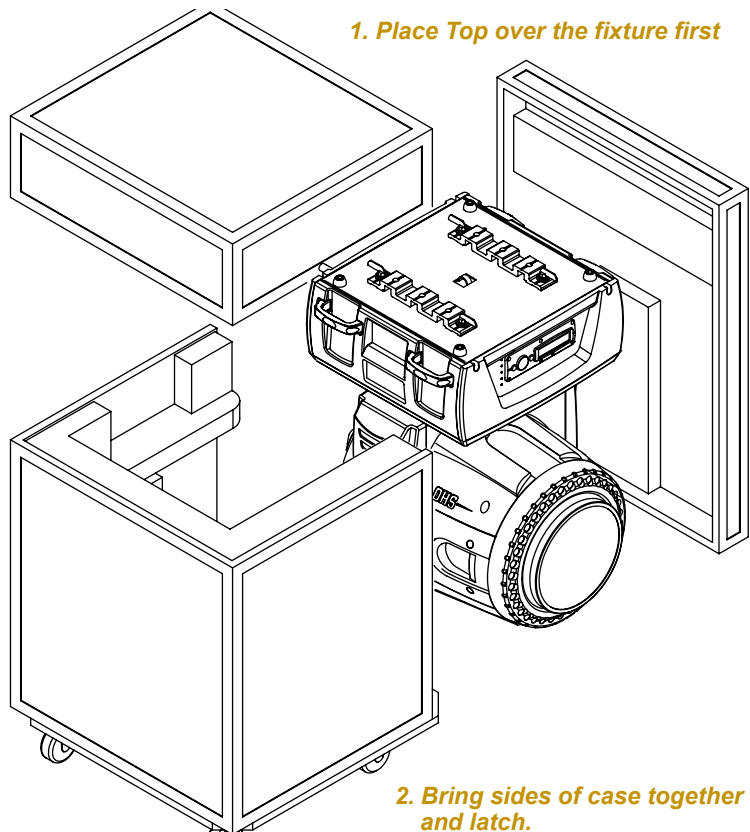

2. Bring sides of case together and latch.

Chapter 3:

Menu System

The onboard Menu system for SHOWBEAM 2.5 fixtures provides fixture configuration options. This chapter shows you how to access and navigate the Menu System, the options available at each Menu level, and includes examples.

Navigating the Menu System

The onboard Menu system lets you perform the following functions at the fixture level:

- Assign a DMX start channel
- Access and set fixture options
- View fixture status
- Crossload software between fixtures

The SHOWBEAM 2.5™ Display

The front panel on SHOWBEAM 2.5 fixtures has a dot matrix display and six arrows for navigation. This display reduces the menu levels required and dramatically increases usability with the capability of displaying up to two 16-character lines of text.



Use Left and Right arrows to move through the current menu level options

Use Up and Down arrows to select from available value or setting options.

Use the **Menu** button (on the left when viewing the display) to unlock the menu move to the previous menu level

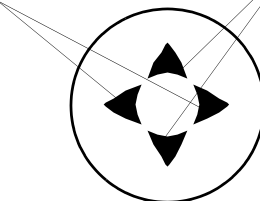

Use the four-way **Center** button to navigate through levels

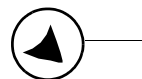

Use the **Enter** button (on the right when viewing the display) to select a menu value or option.

The SHOWBEAM 2.5 fixture can sense orientation and automatically inverts the display and the Center button's functions when the fixture is mounted upside down.

Navigational Basics

1. Unlock the Menu system by pressing the **Menu** ▼ button for a few seconds until the display goes to the 2-line format.
2. Use the left and right arrows ◀▶ on the **Center** button to scroll through menu options at the current level.
3. Stop at the desired menu and press the **Enter** ▲ button to select.
4. If there is another level of menu choices repeat Steps 2 and 3.
5. At the option or setting level of the menu, use the Up and Down arrows ▲▼ on the **Center** button to scroll to the desired option or setting. The option flashes until the **Enter** button is pressed. Pressing the **Enter** button stores the new value for that option. Pressing the **Menu** button returns to the previous menu level *without changing* the value of an option.

Note: *The new option will not be stored unless the Enter button is pressed.*

6. Continue pressing the **Menu** button to move back up levels until exiting the Menu system.

Display in Menu Locked Mode

The SHOWBEAM 2.5 display panel gives access to the fixture's onboard Menu System. When the Menu System is in locked mode, the panel displays in large 8-character format designed to be viewed from a distance. Under normal circumstances, when the display is locked, it cycles between displaying the SHOWBEAM 2.5 logo, the High End Systems logo, the fixture's software version [v##.##], and the fixture's DMX start channel [DMX_C###]. Any errors present are also displayed in an 8-character error description.

Fixture Software Version

The software version loaded on the fixture can vary even between units purchased at the same time. The latest software version is always posted on the High End Systems website (www.highend.com/support).

DMX Start Channel

The DMX Start Channel is the first channel currently assigned to that fixture in its range of channels on a DMX link. To reset the DMX start channel, see *Setting DMX Start Channel* on page 20. For more information on DMX Start channels, see *Determining DMX Start Channel Assignment* on page 20.

Error Message Display

Errors are displayed in large 8-character form when the menu system is locked. Unlocked, the menu system's 2-line format displays more detailed information. For information on accessing the detailed error message, see *Display Errors* on page 29.

Unlocking the Menu System

To unlock the menu system, press and hold the **Menu** button until the display changes to the two-line format. You will need to hold the Menu button for a few seconds before the menu unlocks to protect against an inadvertent menu change. DMX Address Menu is the first option on the top menu level.

Exiting the Menu System

To exit the menu system, keep pressing the Menu button to back out of each menu level until the High End Systems logo appears. The word `AUTOLOCK` will appear briefly on the display to indicate the fixture's software is "locking" the display. The display switches back to the large 8-character format and, after a few seconds, begins the standard display for the locked mode as described above.

Menu Map

Level 1	Level 2	Option/Setting	Description/Notes
DMX ADDRESS MENU	SET DMX START CHANNEL: ###	1 4 8 1	Selected value becomes the first DMX value in the range for that fixture on a DMX 512 link.
SET PARAMETERS MENU	FACTORY DEFAULT SETTINGS: ###	ON	Reverts fixture to default setting
		OFF	Indicates a factory default has changed
	PAN/TILT SWAP:	DISABLED	Restores default Pan and Tilt Motion
		ENABLED	Swaps the Pan and Tilt Motion
	PAN INVERT:	DISABLED	Restores default Pan motor direction
		ENABLED	Inverts Pan motor direction
	TILT INVERT:	DISABLED	Restores default Tilt motor direction
		ENABLED	Inverts Tilt motor direction
	DISPLAY LEVEL:	ON	Turns display ON
		OFF	Display fully dimmed when menu is locked
	LAMP LIFE LIMIT:	DISABLED	Disables lamp life tracking
		ENABLED	Tracks the time the lamp is on and sends a warning when the lamp approaches it's rated life limit.
	DATA LOSS TIMEOUT:	SHORT	Shutter closes 1 second after data loss
		LONG	Shutter closes when fixture shuts down

Level 1	Level 2	Option/ Setting	Description/Notes	
TEST MENU	HOME FIXTURE:	ALL	Homes all fixture functions	
	LAMP STATE:	OFF	Indicates or turns lamp off	
		ON	Indicates or turns lamp on	
	COPY BOOT:	NO	Does nothing when selected	
		YES	Copies boot code to fixture	
	SELF TEST MENU	CHASSIS	PAN	Test movement function
			TLT	
		HEAD	CYAN	Tests flag, lens and wheel functions
			MAGENTA	
			YELLOW	
			CTO	
			STATC COLOR	
			EFFECTS	
			ZOOM	
			DM	
	RNG RED			
	RNG GREEN			
	RNG BLUE			
	DISPLAY TEST	OFF	Default Safe setting	
ON		Performs Display test		
SETUP MOTORS	OFF	Default Safe setting		
	ON	Runs motor setup routine		
ENCODER TEST	ON	Disables encoders		
	OFF	Leaves encoders enabled		
CAL RGB LEDS	OFF	Default Safe setting		
	ON	Calibrates the RGB LEDs		
CODE MENU			For factory use only	
INFORMATION MENU	SENSOR STATUS MENU	PAN ENCODER	Displays absolute position of Pan	
		TILT ENCODER	Displays absolute position of Tilt	
	UNIQUE NUMBER #####		Displays fixture's unique 10-character number	
	DMX VALUES MENU	1 ### ## #	Displays current values for all channels in groups of six DMX values/screen	
		4 ### ## #		
	TEMPERATURES MENU	CURRENT	After selecting CURRENT, MAXIMUM or MINIMUM, you can view the temperature for the following sensors: TO PBOX: ##C HEAD 1: ##C LED TRACKING: ##C	
MAXIMUM				
MINIMUM				
TEMP RESET		Default setting is NO. Select YES and press Enter for 5 seconds to reset all sensors to Current Temperature		
FIXTURE HOURS:			Displays fixture operation time in hours:minutes	

Level 1	Level 2	Option/ Setting	Description/Notes
INFORMATION MENU	FIXTURE HOURS RESET:	NO	Default "safe" setting
		YES	Press Enter for 5 seconds to reset fixture hours to 0
	LAMP HOURS :		Displays lamp operation time in hours:minutes
	LAMP STRIKES :		Displays current number of lamp strikes
	LAMP HR/STRIKE RESET:###	NO	Default "safe" setting
		YES	Press Enter for 5 seconds to reset fixture hours to 0
	FAN SPEED	BLOWER1 : XXXXRPS	Displays the current speed of the two fans located in the fixture head
		BLOWER2 : XXXXRPS	
	LAMP STATUS :	LAMP OFF	Displays current lamp status
		LAMP ON	
		LAMP STRKNG	
		LAMP ERROR	
	SOFTWARE VERSION :	V ##.##.###	Major.Minor.Build
	DISPLAY ERRORS MENU	XXXXXXXXXXXXXX XXXXXXXXXXXXXX	Scrolls through errors displayed in 2-line, 16-character format
CHANNELS NEEDED :	##	Displays channel range for current configuration (32 for SHOWBEAM 2.5 fixtures)	
NEXT DMX CHANNEL:	##	(Current start channel + channels needed+1)	

Menu System Options

The following sections describe and give examples for selecting and/or setting available menu options.

DMX Address Menu

DMX Address is the top level menu selection used to set the fixture's DMX start channel. Use this menu option, to change the *existing* DMX start channel to another DMX start channel.

Setting DMX Start Channel

To set the DMX start channel:

1. Press the **Menu** button to unlock the menu system or to move back up the system to the top level menus. `DMX ADDRESS MENU` is the first menu item at the top level.
2. Press the **Enter** button to select. The display will show `SET DMX START CHANNEL###`. The display will show the start channel currently assigned to the fixture.
3. Use the up and down arrows on the **Center** button to select a new DMX start channel from 001– 481. The display will flash a new option ready for selection.

Note: *The last valid Start channel for a SHOWBEAM 2.5 fixture is 481 (512–32+1).*

4. Press the Enter button to accept the new DMX Start channel.

Note: *If the Enter button is not pressed, the old value will remain selected after exiting the menu.*

Determining DMX Start Channel Assignment

There are 512 available channels on each DMX link divided among *all* the devices in a particular link. A fixture must have a *unique* Start channel number in order to respond *independently* to controller commands.

To determine each fixture's DMX start channel in a link, identify the channel range of every fixture on the link. Channel range is the number of consecutive channels a fixture requires. Each SHOWBEAM 2.5 fixture requires a block of 32 consecutive channels on a 512-Channel DMX link. The Start channel is the first number of a fixture's channel range.

The notes in the following table show the various considerations in determining valid Start Channels for fixtures on a 512 DMX link. A single 512-Channel DMX link can accommodate up to sixteen SHOWBEAM 2.5 fixtures.

Fixture location on the link	Fixture type	DMX channels used per fixture	DMX Start channel	Channel range used	Notes
First	SHOWBEAM 2.5	32 channels	C001	1-32	The Start channel is the number of the first channel in a consecutive block of channels assigned to a fixture.
Third	SHOWBEAM 2.5	32 channels	C031	33-65	Fixture can be assigned the second block of DMX channels without physically being the second fixture on the link.
Second	SHOWBEAM 2.5	32 channels	C069	69-101	To avoid overlapping channels, place the start channel at the beginning of a range of available channels large enough to accommodate that fixture type
Fourth	Studio Spot	18 channels	C121	121-138	Every channel in the link does not need to be assigned.

When setting the Start channel on a fixture, remember:

- A fixture's physical location on the link does not have to coincide with the order of channel range assignments in the link. See Row 2 in the above table.
- The fixture's channel range must not overlap any other device's channel range on the link. When two devices on the same DMX link have overlapping channel ranges, one or both devices will be disabled or behave erratically. The single exception would be if two or more fixtures need to respond to controller commands in exactly the same way. In that case, those fixtures must be the same type (for example two SHOWBEAM 2.5 fixtures) and must share the *entire* channel range.

Set Parameters Menu

The Set Parameters menu sets all factory options to their default settings or changes the factory options individually.

Factory Default Settings

A SHOWBEAM 2.5 fixture ships with the following factory default settings:

Pan Tilt Swap=DISABLED	Tilt Invert=DISABLED	Lamp Life Limit=DISABLED
Pan Invert=DISABLED	Display Level=ON	Data Loss Timeout=SHORT

If any of the default settings are changed, this menu reverts to the OFF option. The ON option restores all factory defaults.

To check and reset factory defaults:

1. Press the **Menu** button to unlock the menu system or to move back up the system to the top level menus.
2. Using the left and right arrows on the **Center** button, scroll through the top level to SET PARAMETERS MENU and press the Enter button to select.
3. Using the left and right arrows on the **Center** button, scroll to FACTORY DEFAULT SETTINGS. The current state (ON or OFF) will be displayed.
4. To reinstate the factory defaults if OFF is displayed, use the up and down arrows on the **Center** button to scroll to ON and press the **Enter** button to select.

Pan/Tilt Swap

This option swaps the pan motor and tilt motor operation to coordinate movements between fixtures on a link mounted perpendicular to each other.

To swap Pan and Tilt:

1. Press the **Menu** button to unlock the menu system or to move back up the system to the top level menus.
2. Using the left and right arrows on the **Center** button, scroll through the top level to SET PARAMETERS MENU and press the **Enter** button to select.
3. Using the left and right arrows on the **Center** button, scroll to PAN/TILT SWAP. The current state (ENABLED or DISABLED) will be displayed.
4. Use the up and down arrows on the **Center** button to scroll to ENABLED to swap pan and tilt or DISABLED to revert fixture to default setting and press the **Enter** button to select.

Pan Invert

This menu option inverts the direction of the pan motor to coordinate movements between fixtures mounted opposite each other horizontally.

To invert the fixture's Pan motion:

1. Press the **Menu** button to unlock the menu system or to move back up the system to the top level menus.
2. Using the left and right arrows on the **Center** button, scroll through the top level to `SET PARAMETERS MENU` and press the **Enter** button to select.
3. Using the left and right arrows on the **Center** button, scroll to `PAN INVERT`. The current state (`ENABLED` or `DISABLED`) will be displayed.
4. Use the up and down arrows on the **Center** button to scroll to `ENABLED` to invert Pan movement or `DISABLED` to revert fixture to default setting and press the **Enter** button to select.

Tilt Invert

This menu option inverts the direction of the tilt motor to coordinate movements between fixtures on a link facing each other vertically.

To invert the fixture's Tilt motion:

1. Press the **Menu** button to unlock the menu system or to move back up the system to the top level menus.
2. Using the left and right arrows on the **Center** button, scroll through the top level to `SET PARAMETERS MENU` and press the **Enter** button to select.
3. Using the left and right arrows on the **Center** button, scroll to `TIPT INVERT`. The current state (`ENABLED` or `DISABLED`) will be displayed.
4. Use the up and down arrows on the **Center** button to scroll to `ENABLED` to invert Tilt movement or `DISABLED` to revert fixture to default setting and press the **Enter** button to select.

Lamp Life Limit

Use this menu option to display the warning message Lamp Life Error when the current lamp hours reach the rated lamp life. When the `LAMP LIFE LIMIT` parameter is enabled, the fixture tracks the number of hours the lamp is on. As the lamp life approaches its limit, the fixture displays an error message. At close to the lamp life limit, the lamp shuts off, and the fixture will not strike until the lamp is replaced and the lamp hours are reset to 0. See *Replacing the Lamp* on page 43 and *Lamp HR/Strike Reset* on page 28.

To enable the `LAMP LIFE LIMIT` parameter:

1. Press the **Menu** button to unlock the menu system or to move back up the system to the top level menus.
2. Using the left and right arrows on the **Center** button, scroll through the top level to `SET PARAMETERS MENU` and press the **Enter** button to select.
3. Using the left and right arrows on the **Center** button, scroll to `LAMP LIFE LIMIT`.
4. Using the up and down arrows on the **Center** button, choose the `ENABLE` option and press **Enter** to select.

Data Loss Timeout

Use this menu option to determine how the fixture will react in the event of DMX data loss. Set the shutter to stay open until shutdown or to close one second after data loss.

To set the `DATA LOSS TIMEOUT`:

1. Press the **Menu** button to unlock the menu system or to move back up the system to the top level menus.
2. Using the left and right arrows on the **Center** button, scroll through the top level to `SET PARAMETERS MENU` and press the **Enter** button to select.
3. Using the left and right arrows on the **Center** button, scroll to `DATA LOSS TIMEOUT`.
4. Using the up and down arrows on the **Center** button, choose `LONG` to keep the shutter open until shutdown, or `SHORT` to close the shutter 1 second after data loss and press the **Enter** button to select.

Test Options Menu

Homing the Fixture

The SHOWBEAM 2.5 fixture automatically homes all its functions whenever it is turned on. To manually home the fixture:

1. Press the **Menu** button to unlock the menu system or to move back up the system to the top level menus.
2. Use the left and right arrows on the **Center** button to scroll to the `TEST OPTDNS MENU` and press the **Enter** button to select.
3. Use the left and right arrows on the **Center** button to scroll to `HOME FKTURE`.
4. Press the **Enter** button to store the selection. The fixture will begin homing.

Lamp State

The `LAMP STATE` option in the `TEST OPTDNS` menu turns the lamp `ON` or `OFF`.

Copying the Boot Code

When new software is uploaded to SHOWBEAM 2.5 fixtures, it may contain a new boot code which must be copied to each fixture. This is apparent if the fixture displays a `BOOTDEF` error.



CAUTION:
Do not remove power from the fixture while performing a boot copy.

To accept and store the new boot code:

1. Press the **Menu** button to unlock the menu system or to move back up the system to the top level menus.
2. Using the left and right arrows on the **Center** button, scroll to the `TEST OPTDNS MENU` and press the **Enter** button to select.
3. Using the left and right arrows on the **Center** button, scroll to the `COPY BOOT` option and press the **Enter** button to select.
4. Use the up and down arrows on the **Center** button to scroll to the `YES` option and then press the **Enter** button to store the command. The fixture will store the new boot code, then automatically home.

Motor Setup

This option is used when calibrating flag motors in Production Homing, see *Production Homing* on page 47.

Information Menu

The Information menu displays current fixture information such as internal temperature, lamp hours, total fixture hours, lamp strikes, hardware and software versions, DMX errors, and view DMX data for any device on the link. Lamp and Fixture hours resets are also executed in the Information Menu.

Sensor Status Menu

The Sensor Status displays the current numeric position of the fixture's encoders. To view encoder values:

1. Press the Menu button to unlock the menu system or to move back up the system to the top level menus.
2. Use the left and right arrows on the **Center** button to scroll to the `INFORMATDN MENU` and press the Enter button to select.
3. Use the left and right arrows on the **Center** button to scroll to the `SENSOR MENU` and press the Enter button to select.
4. Use the left and right arrows on the **Center** button to scroll to view `PAN ENCODER` or `TLT ENCODER` value.

Unique Number

Each SHOWBEAM 2.5 fixture has a unique number similar to a serial number. Use this option to view the fixture's unique number.

DMX Values Menu

This menu option lets you view the current DMX value for every channel on the DMX link that includes this fixture.

To help you navigate through all the channels on the link, the menu displays the values for Channels 001– 512 in two lines of three DMX values you can scroll through using the up and down buttons. The number at the beginning of each line indicates the first channel with a value displayed on that line. For example, line `1 ### ## #` displays values for channels 1,2, and 3. Line `4 ### ## #` displays values for channels 4, 5, and 6. To access the `DMX VALUES MENU`:

1. Press the **Menu** button to unlock the menu system or to move back up the system to the top level menus.
2. Use the left and right arrows on the **Center** button to scroll to the `INFORMATDN MENU` and press the **Enter** button to select.
3. Use the left and right arrows on the **Center** button to scroll to the `DMX VALUES MENU` and press the **Enter** button to select.
4. Use the up and down arrows scroll through the channel range. The display shows 6 DMX values per screen in two lines of 3 values each. The number at the beginning of the line indicates the channel number corresponding to the first value in that line.

Temperatures Menu

The SHOWBEAM 2.5 fixture contains temperature sensors that track current, maximum and minimum temperatures produced in the unit. Sensors monitor the air temperature of the electronics housing, the lamp housing, and the LED System.

Initially, the setting for current, maximum and minimum temperatures are equal. As the sensor detects temperature changes, the fixture adjusts the minimum and maximum settings.

To view maximum temperature the LED System reached since the last reset:

1. Press the **Menu** button to unlock the menu system or to move back up the system to the top level menus.
2. Use the left and right arrows on the **Center** button to scroll to the `INFORMATION MENU` and press the **Enter** button to select.
3. Use the left and right arrows on the **Center** button to scroll to the `TEMPERATURES MENU` and press the **Enter** button to select.
4. Use the left and right arrows on the **Center** button to scroll to `MAXIMUM`. Press the **Enter** button to select.
5. Use the up and down arrows on the **Center** button to scroll to `LED TRACKING`. Press the **Enter** button to select and view the temperature recorded in degrees centigrade.

To reset all the temperature readings back to the current temperature:

1. Press the **Menu** button to unlock the menu system or to move back up the system to the top level menus.
2. Use the left and right arrows on the **Center** button to scroll to the `INFORMATION MENU` and press the **Enter** button to select.
3. Use the left and right arrows on the **Center** button to scroll to the `TEMPERATURES MENU` and press the **Enter** button to select.
4. Use the left and right arrows on the **Center** button to scroll to `RESET TEMPERATURE`. Press the **Enter** button to select. The display will read NO. Use the up and down arrow to scroll to YES and hold for 5 seconds to reset all sensors to the current temperature in centigrade.

Fixture Hours

Use this option to view the fixture operation time in hours and minutes.

Fixture Hours Reset

Use this option to reset the fixture operation time to Zero.

To access the `FXTURE HOURS RESET` option:

1. Press the Menu button to unlock the menu system or to move back up the system to the top level menus.
2. Use the left and right arrows on the **Center** button to scroll to the `INFORMATDN MENU` and press the Enter button to select.
3. Use the left and right arrows on the **Center** button to scroll to the `FXTURE HOURS RESET` option and press the Enter button to select.
4. Use the up and down arrows on the **Center** button to scroll to `YES`. Press and hold the Enter button down for 5 seconds to select.

Lamp Hours

Use this option to view the lamp operation time in hours and minutes.

Lamp Strikes

Use this option to view the total number of lamp strikes.

Lamp HR/Strike Reset

After installing a new lamp the Lamp hours and Lamp strike sensors must be reset to 0 before the Lamp will strike.

To access the `LAMP HR/STRIKE RESET` option:

1. Press the Menu button to unlock the menu system or to move back up the system to the top level menus.
2. Use the left and right arrows on the **Center** button to scroll to the `INFORMATDN MENU` and press the Enter button to select.
3. Use the left and right arrows on the **Center** button to scroll to the `LAMP HR/STRIKE RESET` option and press the Enter button to select.
4. Use the up and down arrows on the **Center** button to scroll to `YES`. Press and hold the Enter button down for 5 seconds to select.

Lamp Status

This option displays the current Lamp Status as `LAMP OFF`, `LAMP ON`, `LAMP STRKING`, or `LAMP ERROR`.

Software Version

This option display's the fixture's CPU board Software version. The version number is composed of: V(Major).(Minor).(Build).

Display Errors

This menu option displays current errors in a descriptive 32-character text field.

To `DISPLAY ERRORS`:

1. Press the **Menu** button to unlock the menu system or to move back up the system to the top level menus.
2. Use the left and right arrows on the **Center** button to scroll to the `INFORMATION MENU` and press the **Enter** button to select.
3. Use the left and right arrows on the **Center** button to scroll to the `DISPLAY ERRORS` menu option and press the **Enter** button to select.
4. Use the up and down arrows on the **Center** button to view the list of current errors.

Next DMX Channel

Use this option to view the next available DMX Start channel on the link following this fixture and is based on the fixture's specific configuration. The value displayed uses the formula (current Start channel + 30 +1).

Chapter 4:

Fixture Programming

SHOWBEAM™ 2.5 fixtures can be programmed to provide a soft wash or hard edge beam with full CMY color, static color options, LED tracking, and a Twin Beam effect as well as a variety of Shutter/Lamp functions.

DMX Programming Overview

A parameter is a fixture attribute that can be controlled to modify the light beam in terms of color, beam quality and pattern, intensity, or focus (position). DMX programming assigns a DMX value to each of the fixture's parameters. A look (sometimes referred to a *scene* or a *cue*) is one combination of parameter settings. These looks are the building blocks for show creation.

Full Speed versus MSpeed Control

Some parameters can be set to operate at full speed or MSpeed (motor speed). Full speed operations are completed in the shortest length of time after the motor starts moving. With MSpeed control, change occurs smoothly over the entire MSpeed time value selected. For example, if you select an MSpeed time of 30 seconds, the motor will gradually change position until it reaches its new destination at the end of 30 seconds.

DMX Programming Options

Using a DMX controller, you can program an unlimited number of looks and retain direct control over the SHOWBEAM 2.5 fixture at all times.

Programming with a DMX Console

Wholehog® lighting consoles; and Hog® 3PC software are available from High End Systems to control SHOWBEAM 2.5 fixtures (see *Related Products and Accessories* on page 2). For information on whether your DMX controller supports SHOWBEAM 2.5 fixtures, contact the controller's vendor. For information on operating your fixture with a controller (or control device such as DMX control software), consult the documentation provided with the controller.

SHOWBEAM 2.5 DMX Parameters

DMX console libraries define parameters for the following SHOWBEAM 2.5 functions over a 32-channel range and are copyrighted and available in High End Systems consoles. For information on developing libraries for DMX consoles from other manufacturers, contact High End Systems.

Channel	Function
1	Pan
2	
3	Tilt
4	
5	Color Mix Function
6	Cyan
7	Magenta
8	Yellow
9	CTO
10	Static Color Function
11	Static Color Position
12	Twin Beam
13	Twin Beam Rotate Function
14	Twin Beam Rotate
15	
16	Twin Beam Deviation

Channel	Function
17	Zoom Bypass
18	Zoom
19	Shutter/Lamp Functions
20	Shutter
21	Dim
22	MSpeed
23	Macro
24	Control
25	LED Tracking Dim
26	LED Tracking Function
27	LED Tracking Red
28	
29	LED Tracking Green
30	
31	LED Tracking Blue
32	

Pan and Tilt

The **Pan** and **Tilt** parameters control the SHOWBEAM 2.5 fixture's 420° pan range and 216° tilt range. Pan and Tilt functions each utilize two channels to provide 16 bit adjustment to a fraction of a degree.

Pan and Tilt motion for SHOWBEAM 2.5 fixtures can be controlled with MSpeed values, (see *MSpeed (Motor Speed)* on page 39). If you choose to use MSpeed for color changes without affecting Pan and Tilt parameters, set Pan/Tilt MSpeed OFF in the Control parameter.

Note: *Optical encoders for pan and tilt correct the fixture's position if the fixture is jarred from its programmed position. If a physical obstruction prevents the fixture from correcting its position, the fixture "times out" to prevent wear on the motors. If your fixture has timed out, remove the obstruction and home the fixture to return it to normal operation.*

Color Control

The SHOWBEAM 2.5 fixture has two color mixing systems and static color options. Color mixing of the main beam utilizes CMY dichroic flags. The 36 RGB Modules in the LED Tracking system use an RGB color mixing system. In addition a CTO flag lets you adjust color temperature.

Color Flags

CMY Color Mixing

The CMY color mixing system creates an infinite range of color by moving pairs of Cyan, Magenta and Yellow flags. Several color selection modes are available in either full speed (controller crossfading the flag positions), or MSpeed (MSpeed control of the flag motor). For more information on MSpeed, see *MSpeed (Motor Speed)* on page 39.

The Color Function you choose will effect which parameter values are available for each individual color (Cyan, Magenta, and Yellow). The following table describes the Color Functions available in the SHOWBEAM 2.5 fixture.

Color Function	Description
Continuous	Allows exact positioning of the color flags
Random	Selects whole color positions at variable speeds
Cycle	Cycles through colors
Tri-Color, single flag	Controls movement of one flag of a pair with the other flag open
Tri-Color, dual flag	Controls movement of one flag of a pair with the other flag closed (fully saturated)

Tri Color Effect

Independent control over individual flags in each color pair allows you to create tri-color beam effects. You can choose whether to control one or both flags of a pair.

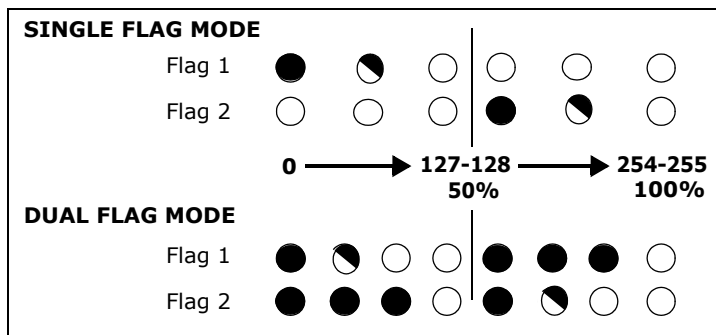

Note: When applying this effect in conjunction with the Twin Beam effect, you can project dual beams with identical color modes.

CTO

A CTO flag gives you variable color temperature control.

Static Color Wheel

A fixed color wheel provides three dichroic colors selected with the **Static Color Position** parameter:

Color	DMX Value range
Red	64-127 (26%-50%)
Pink	128-191 (51%-75%)
Amber	192-255 (76%-100%)

Several color selection modes are available in either full speed or MSpeed (MSpeed control of the wheel motor). For more information on MSpeed, See *MSpeed (Motor Speed)* on page 39. The **Static Color Function** parameter provides the following options for controlling the Static Color Wheel:

Static Color Function	Description
Indexed	Takes the quickest path and snaps to the chosen color on the wheel.
Forward Spin	Spins the wheel forward through the colors at variable speeds.
Reverse Spin	Spins the wheel in reverse through the colors at variable speeds.
Fast Scan	Performs a scan of one static color position from each side.
Random	Selects random static color positions at variable speeds.
Blink	Closes and opens the shutter between indexed static color changes.

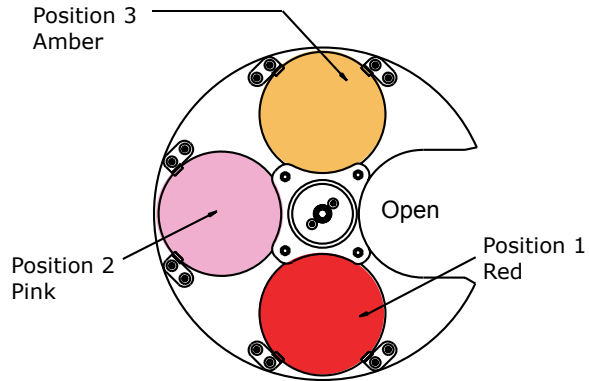

Zoom

The SHOWBEAM 2.5 fixture utilizes a radial lenticular array homogenizing lens that is composed of two lenticular doors. When the lenticular doors are opened, they allow the isosceles prism array to create the Twin Beam effect. When the lenticular lens doors are closed, the **Zoom** Parameter lets you control the lens movement. The narrowest angle is selected with a DMX value = 0. Increasing values widens the beam to the maximum beam angle at a DMX value = 255 (100%).

Note: *If the Twin Beam parameter has a DMX value > 0, the DMX value for the Zoom parameter will be ignored. When the Twin Beam parameter has a DMX value = 0, the selected DMX value for the Zoom parameter will be recognized.*

Zoom Bypass

The **Zoom Bypass** parameter lets you create a hard edge beam effect by opening the lenticular doors at a variable rate. The **Zoom** parameter must be set to a DMX value = 0 to control **Zoom Bypass**. Adjust the **Zoom Bypass** parameter from the softest edge beam at a DMX value = 0 to a hard edge beam at a DMX value = 255 (100%).

Note: If the Twin Beam parameter has a DMX value > 0, the DMX value for the Zoom Bypass parameter will be ignored. When the Twin Beam parameter has a DMX value = 0, the selected DMX value for the Zoom Bypass parameter will be recognized if the Zoom parameter has a DMX value = 0.

Twin Beam Effect

When you activate the **Twin Beam** effect, the lenticular lens doors open and the isosceles prism array moves into the light path. When you deactivate the Twin Beam effect, the lenticular lens doors close and the isosceles prism array moves out of the light path.

Note: The mechanical actions necessary to activate or deactivate the Twin Beam effect take a few seconds to execute and need to be considered in programming your show.

Twin Beam Parameter

When you enable the **Twin Beam** parameter, the **Zoom** parameter is ignored and the zoom moves to the DMX zero position and opens the lenticular doors automatically. When the **Twin Beam** parameter is at DMX values from 0-127 (0-50%), the **Zoom** and **Zoom Bypass** parameters will function via DMX control.

When the **Twin Beam** parameter has a DMX value from 128-255 (50%-100%), the isosceles prism array moves into the light path and the lens automatically moves to a zero position and opens the lenticular doors. At this time the **Zoom** and **Zoom Bypass** parameters' DMX values will be ignored.

Twin Beam Deviation Parameter

As the isosceles prism travels forward through the opened lenticular doors, you can control the distance between the twin beams (deviation) by setting the **Twin Beam Deviation** parameter from the narrowest spread at a DMX value = 0 to the widest spread at a DMX value = 255 (100%).

Twin Beam Rotation

The **Twin Beam Rotate Function** provides several rotation modes for the Twin Beam effect.

Twin Beam Rotate Function Options	Description
Indexed	Takes the quickest path and snaps to the twin beam position.
Forward Rotate	Rotates the twin beam pattern clockwise at variable speeds.
Reverse Rotate	Rotates the twin beam pattern counterclockwise at variable speeds.
Blink	Closes and opens the shutter between indexed twin beam changes.
Forward Animate	Adds a stepping motion to a clockwise rotation
Reverse Animate	Adds a stepping motion to a counterclockwise rotation

The **Twin Beam Rotate** parameters use two channels to provided fine rotation adjustment of Index and Blink Modes. The **Twin Beam Rotate** parameter adjusts the rotation rate from the slowest at a DMX value of 4 (1%) to fast rotation at a DMX value = 255 (100%).

LED Tracking System

The LED Tracking System uses Red, Green and Blue LEDs (RGB) to produce a color spectrum you can control and dim independently from the main output beam. There are 36 RGB LED modules that make up the LED Tracking System. Each RGB Module consists of a homogenizing lens and an RGB die.

The LED Tracking System uses 3 watt LEDs that can produce close to 5000 lumens of light and can be used along with or independent from the main output. The LED Tracking System allows you to select any LED color you desire.

LED Tracking Functions

The LED Tracking System is capable of strobing and other effects independent from those applied to the main output beam.

Color Function	Description
Continuous	Allows exact intensity control of each LED color.
Random	Selects whole colors at variable speeds.
Cycle	Cycles through colors.
Periodic Strobe	Strobes LEDs at specified intervals.

LED Tracking System Dimming

Most automated luminaires have a single intensity system. In addition to the main output intensity, the SHOWBEAM 2.5 provides an additional intensity system for the LED Tracking System. It operates in two modes.

Dim Tracking Mode

In this mode, the LED Tracking System dims as the main output dims. When the Output Dim channel is set at a lower intensity, it will override the LED Tracking Dim channel. Visually, the lowest level takes precedence. This ensures that both intensity systems black out when the main output blacks out (for example, when using the console's Grand Master)

NOTE: *You can view LEDs alone in the tracking mode if you close the lamp shutter.*

Tracking System Independent Dim Mode

In this mode, the Dim parameter operates independently from the LED Tracking Dim Parameter, allowing separate control over output dimming and LED dimming.

NOTE: *This mode may result in SHOWBEAM 2.5 fixtures outputting LED intensity when the console Grand Master is at zero.*

Shutter and Lamp Effects

The **Shutter/Lamp Function** channel determines how the **Shutter** channel will function. When you select one of the following options in the **Shutter/Lamp Function** channel, the **Shutter** channel sets the strobe rate from slow to fast.

Shutter/Lamp Function	Shutter Channel
Close	Closes shutter
Normal Shutter Functions	Strobes beam at specified intervals from slow to fast.
Random Strobe	Allows all SHOWBEAM 2.5 fixtures on the DMX link to strobe their shutters at random times from slow to fast.
Random/Synchronous Strobe	Allows all SHOWBEAM 2.5 fixtures on the DMX link to strobe their shutters at random times in unison from slow to fast.
Lamp Functions	(see next table)
Open	Opens shutter

When you select the Lamp Functions option in the **Shutter/Lamp Function** channel, the **Shutter** channel lets you create lamp boost, lightning and strobing effects.

Shutter/Lamp Function	Shutter Channel
Lamp Functions	Closes shutter
	Periodic lamp strobes lamp at specified intervals from slow to fast.
	Allows all SHOWBEAM 2.5 fixtures on the DMX link to strobe their lamps at random times from slow to fast.
	Allows all SHOWBEAM 2.5 Fixtures on the DMX link to strobe their lamps at random times in unison from slow to fast.
	Boost lamp, black. Six time ranges from 1-.25 second ^{Note}
	Boost lamp, white. Six time ranges from 1-.25 second ^{Note}
	Lightning strikes. Six lightning variations are available. ^{Note} The Dim channel scales the overall brightness of the lightning strobe.
	Opens shutter

NOTE: *The Boost effect boosts the Lamp above the fixture's Watt level for the specified period of time. The lamp is also boosted during the Lightning effects.*

Before another Boost or Lightning effect can occur, the Shutter channel must be moved to either closed or open, or the Lamp Control channel must be moved outside the Lamp Function range.

Boost effects to black boost the lamp for a specified time then close the shutter.

Boost effects to white boost the lamp for a specified time, then leave the shutter open with the lamp dimmed.

MSpeed (Motor Speed)

The **MSpeed** sets the time required for a motor to complete movement when changing from one position to another. MSpeed provides a means for all motors to reach their target position at the same time, even though each motor may have different distances to travel. MSpeed movement is extremely smooth because the fixture controls its own movements and is not dependent on DMX refresh rates.

MSpeed times vary from 0.15 seconds to 252.7 seconds. However, if you apply MSpeed to a parameter, be sure that the delay value (length of time allowed for the entire look) is longer than the MSpeed value to allow the motors to complete their movement before the end of the cue. An MSpeed value that is longer than the delay value could produce an undesirable result; for example, no light output during the scene. For a listing of exact MSpeed times, see *Appendix A: MSpeed Conversion Table* on page 53.

MSpeed can be applied to the Pan and Tilt, Color, and Twin Beam functions. You can disable Pan and Tilt MSpeed with the Control parameter to allow MSpeed to apply only to **Color** and/or **Twin Beam** parameters.

Macros

The Macro parameter controls Internal Effects™ macros. These are factory-programmed sequences that allow you to quickly program complicated looks in one scene (cue). Each Internal Effect™ macro modifies a specific set of parameters, while allowing user control of all other parameters in the scene. The amplitude of the position macro movement is determined by the Pan Coarse channel and Tilt Coarse channel, respectively. The MSpeed channel controls the speed of the macros.

With the MSpeed set at the default value of DMX 0-4, an Internal Effects macro completes its movement in approximately 2.5 seconds. This provides a pleasing look when the additional variation given by using the MSpeed channel is not required. With the MSpeed set between DMX 5-255, Internal Effects macros complete movement at the selected MSpeed time (up to 25 seconds).

Control Settings

The Control parameter activates certain Fixture functions. To access all SHOWBEAM 2.5 Control settings (except for Pan & Tilt MSpeed Off), first select a control channel value, then set the Shutter channel to "0."

NOTE: *The Control channel should not be crossfaded.*

DMX	Control Setting	Description	
0-9	Safe	Disables all Control settings for normal operation.	
10-19	Pan & Tilt MSpeed Off	Sets Pan & Tilt MSpeed to ignore MSpeed settings.	
20-28	Display Off	Sets display to off.	Set Shutter parameter = 0 to access these control options
40-48	Display Bright	Brightens the display characters.	
60-68	Home All	Remotely homes the fixture.	
80-88	Lamp On	Remotely restrikes the fixture's lamp.	
90-98	Lamp Off	Remotely extinguishes the fixture's lamp.	
120-130	Shutdown	Remotely deactivates the fixture. When a fixture is shut down, the lamp is extinguished, power to the motors is disabled, and the display reads CONTROL SHUT DOWN . If a fixture is in shutdown mode, you must home the fixture to bring it back into operation.	

Chapter 5:

Maintenance and Troubleshooting

Maintaining and servicing SHOWBEAM™ 2.5 fixtures includes replacing parts and cleaning the unit. General troubleshooting tips help you identify potential problems.

SHOWBEAM™ 2.5 fixtures have been designed for easy access for service. However, **all service must be performed by qualified personnel only.** Always observe the following cautions and warnings:



CAUTION! TO AVOID INJURY FROM FALLING COMPONENTS:
Never operate with missing or loose fasteners or screws.



WARNING! DANGER OF ELECTRICAL SHOCK:
Class 1 equipment. This equipment must be earthed. Do not connect to an ungrounded supply.
Equipment suitable for dry locations only. Do not expose this equipment to rain or moisture.
Disconnect power before re-lamping or servicing.



Do not project SHOWBEAM 2.5 beam on flammable objects within 6 m (19.7 ft.) or Inflammable objects within 3 m (9.8 ft.).



DANGER-INTENSE HEAT:
Equipment surfaces may reach temperatures up to 150° C (302° F).
Allow the fixture to cool before handling.

Fixture Component Replacement

Replacing Fuses

Locating Fuses

Fuse	Fuse Location and Access	Symptom of Failure
Motor Power Supply Input	One fuse located on each Power Supply's input board.	Fixture shuts down and will not receive power.
Motor Power Supply Output	Two fuses located on the Pan bracket	Fixture shuts down and will not receive power.
Lamp Power Supply Input	Two fuses located on the power supply board next to the mains connection	Lamp will not strike
2-phase driver boards	F1 and F2 on the upper left corner of each board.	Motors driving associated functions will not operate. Board LEDs are off.
3-phase driver boards	One fuse plus one extra on the each board	Pan or Tilt board-related motors and fans will be off.
LED Control Board	One Fuse	LEDs won't light

Replacement Fuses

Fuse	Fuse Type and Rating	Manufacturer	HES Part Number
Motor Power Supply Input	2.5A, 250V, Slow Blow	Littelfuse	90403027EF
Motor Power Supply Output	5A 250V, Slow Blow	Littelfuse	90403012EF
Lamp Power Supply Input	20A, 250V, Very Fast	Bussmann	90403030EF
2-phase Driver Boards	2.5A, 125V, Slow Blow SMF	Littelfuse	90402016EF
3-phase Pan and Tilt Board			
LED Control Board	5A, 125V, Slow Blow SMF	Littelfuse	90412027EF

Replacing the Lamp



RISK OF EXPOSURE TO EXCESSIVE ULTRAVIOLET (UV) RADIATION:

Change shields and lenses if they have become visibly damaged to such an extent that their effectiveness is impaired, for example by cracks or deep scratches.

Never look directly at the lamp while lamp is on.

Do not operate without complete lamp enclosure in place or when lens is damaged. Serious injury may result from the generation of ozone by this lamp system. A proper means of venting must be provided.



RISK OF POSSIBLE LAMP EXPLOSION:

Do not open for five minutes after switching off.

Service and maintenance should be performed only by qualified personnel as determined by the high-pressure lighting fixture manufacturer.



Wear eye and hand protection when re-lamping.



DANGER-INTENSE HEAT:

Equipment surfaces may reach temperatures up to 150° C (302° F). Allow the fixture to cool before handling.



The SHOWBEAM 2.5 is designed for use with a PHILIPS MSR 2500/2 lamp only.

Use of any other type lamp may be hazardous and may void the warranty.

To change the lamp:

1. Loosen the two captive screws open the lamp panel to access the base of the lamp.



2. Rotate the lamp base to align with the slots in the housing and pull out of the fixture. Replace with the appropriate lamp only:
PHILIPS MSR 2500/2

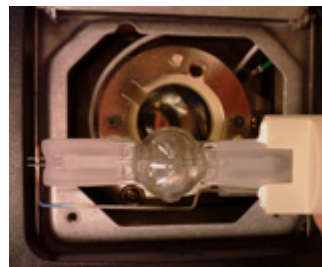

3. Use the three Phillips head screws for lamp optimization.

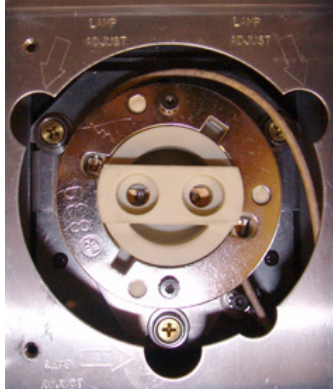

Cleaning SHOWBEAM 2.5 Fixtures

All glass parts should be cleaned with using a mild glass cleaner (containing no ammonia) and a soft, lint-free cotton cloth.

You can use a diffusion cleaning applicator (HES p/n 90901001) to access and clean the color flags.



Lens

You can clean both sides of the Radial Lenticular Array Homogenizing lens without removing it from the fixture.

1. Using your DMX console, set the Zoom parameter DMX value = 255 (100%) to fully extend the lens.
2. Disconnect the fixture from power and, after allowing the fixture to cool, loosen two captive screws to remove the lamp housing door on the same side as the lamp blower exhaust.
3. Rotate the head and clean the outside of the lens.
4. Reach inside the head to clean the back side of the lens.
5. Replace the door, and apply power to re-home the fixture.

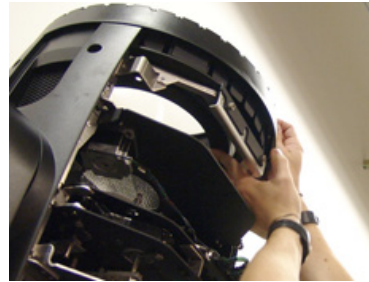

Reflector

1. Loosen two captive screws on each side to remove the two side bezels
2. Loosen four captive screws to remove the rear bezel
3. Using a 3 mm hex, remove the four M4 screws and slide the hot mirror mount out of the unit.
4. Slide the reflector out of the mirror mount.
5. Clean the reflector and replace.

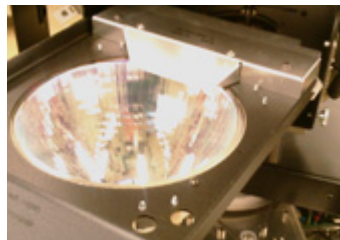
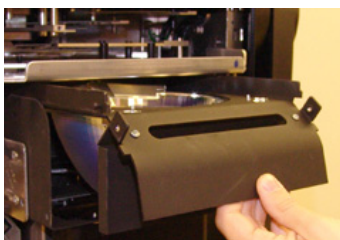

Filter

There is a washable filter located on one side of the electronics housing attached with velcro. Remove, wash with soap and water.

Allow to dry and then reattach.



Production Homing

If dimming or color flags are hitting end stops or if flags don't fully move into the aperture, you can manually recalibrate the flags using the production homing procedure:

1. Access the affected bulk head and remove it from the fixture.
2. Use the service harness headers to replace the connection between the bulk head flag motor and the appropriate 2-phase board location. You can connect one or two flags to the 2-phase board at a time. **Flag 1 is the flag nearer the lamp and Flag 2 is the flag farthest from the lamp on a bulk head.**

NOTE: *The two service harnesses provided are located behind the display panel in the electronics housing.*

3. Select **TEST > SETUP MOTORS > YES** in the menu system to home the flag.
4. Loosen the set screw at the base of the flag using a 2 mm hex key and adjust the flag positioning.
5. Replace the bulk head and home the fixture.

NOTE: *You can also use these steps when replacing a flag.*

Accessing the Bulk Heads

All of the bulk head brackets are held in the unit with two M4 socket caps. Use a 3mm hex key for removal.

Top Bulk Head

Zoom
Twin Beam Actuator

Center Bulk Head

Static Color
Yellow Flags
Cyan Flags

Lower Bulk Head

Dim Flags
Magenta Flags
CTO Flag

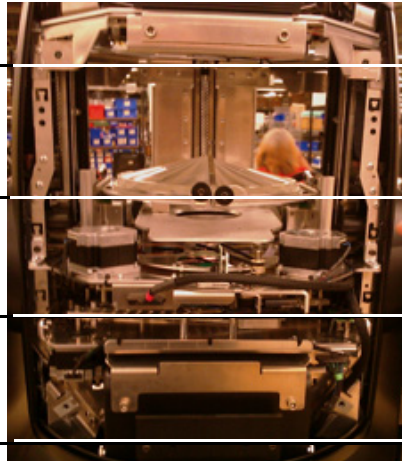

Flag Calibration Example

This example shows you how to recalibrate the dimmer flags:

Connect dimmer flag motors directly to 2-phase driver

1. Detach header from motors powering the two DIM flags on the Lower bulk head.

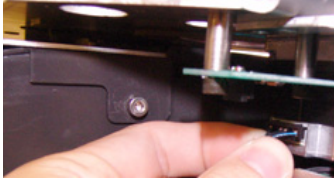

2. Remove the two M4 socket caps and slide the Lower bulk head out of the fixture.

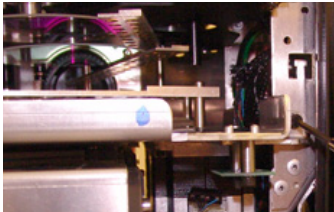

3. Loosen two captive screws to remove electronic housing cover over the display panel and take out the two service harnesses located on the back side of the display panel.

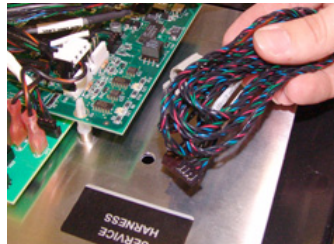

4. Locate the 2-phase board that controls the dimmer motors. Disconnect the M1 and M2 for the two DIM flags on Board 2 (the lower front board of the 4-board bracket inside the fixture).

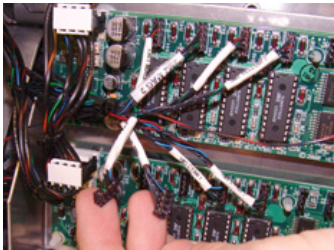

5. Connect one end of a harness to a flag of the dimmer motor and the other to the corresponding header on the 2-phase board (see *page 47*). You can connect and home one flag or a pair of flags at the same time.



Calibrate the flags

6. Power up the fixture. Unlock the Menu system by pressing **Menu** ▼ button for a few seconds until the display goes to the 2-line format.
7. Use the left and right arrows ◀▶ to scroll to the **Test** option. Press **Enter** ▲ to select.

8. Use the up and down ↕ arrows to scroll to **SETUP MOTORS**. Press **Enter** ▲ to select. Use ↕ arrows to scroll to **YES** and press **Enter** ▲ to select. Flags will energize against the standoffs.

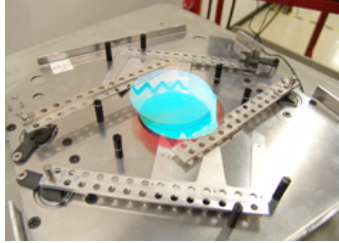

9. Using a 2 mm hex key, loosen the set screw at the base of the flag.

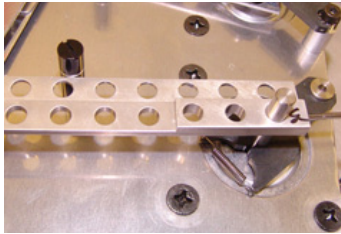

10. Adjust each flag vertically to the tick mark on the inside standoff.

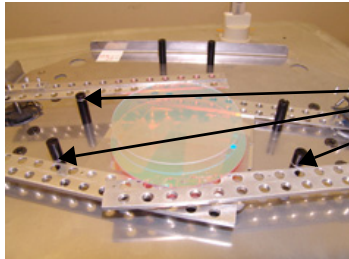

Tick marks for
vertical flag
adjustment

11. Power down the unit. Remove the service harness and re-attach the connectors to the 2-phase driver board.
12. Reinsert the bulk head and replace the two 4M socket caps.
13. Home the fixture and test flags. Make sure they are not hitting when fully closing from the console or the menu system.

Troubleshooting

Power Supply

SHOWBEAM fixtures have two power supplies, PS1 and PS2 that split the power requirements for the different fixture components.

Power Supply	Board Connection	Functions Powered
PS1	LED Control board	LED Tracking
	2-phase board (Address 4)	Lens Door Open 1
		Lens Door Open 2
		Twin Beam Effect
		Twin Beam Rotate
		Twin Beam Sensor
		Twin Beam Rotate Sensor
	2-phase board (Address 1)	Shutter 1
		Shutter 2
		Cyan 1
		Cyan 2
	2-phase board (Address 2)	Magenta Flag 1
Magenta Flag 2		
Yellow Flag 1		
Yellow Flag 2		
5V Status LED		
PS2	Main Board	Pan
		Tilt
		CTO
		Zoom 1
		Zoom 2
		All fans
		Lamp
		Twin Beam Position
		CPU
Display		

System State LEDs

Five labeled LEDs on the display panel indicate the following system activity:

Name	Color	State	Problem?	Description
Status	Green	On	No	(45 sec On/1.4 sec.Off) Running normal motion-control code
		Blinking	No	Board communication activity; for example, during a software upload
		Blinking Slowly	No	320 processor card in the base housing is receiving code.
		Off	Yes	Check that the harness is connected from the HD1 on the LED status board to HD8 on the Tilt board.
Lamp	White	On	No	Lamp is on
		Off	Maybe	Lamp is off
				If the Status Lamp is also off, Check that the harness is connected from the HD1 on the LED status board to HD8 on the Tilt board
		Blinking	No	Lamp is either cooling down or in a indeterminate state
PSU2	Amber	Blinking	No	Power Supply #2 is working
PSU1	Blue	Steady	No	Power Supply #1 is working
5V	Red	Steady	No	Fixture's Motion Control system is receiving power

Board LED States

The CPU, 2-phase, 3-phase, LED Control, and Data Communication boards are mounted for easy access on the bracket located behind the display panel on the electronics housing. LEDs located on the boards help you troubleshoot the unit.

SHOWBEAM 2.5 Board LEDs

Location	LED #	State	Problem?	Description
2-phase Boards 1, 2, and 4	LD1-LD4	Green	No	Associated sensor is open
		Yellow	No	Associated sensor is closed
		Flashing red	No	Board is initializing
		Infinitely flashing red	Yes	Board not receiving data
		Red	Yes	Board not receiving data
		Flashing red and green	Yes	Addressing screw(s) missing from board
		Sporadically flashing green & yellow	Yes	2 boards are addressed the same. (Corrected by adding addressing screw to appropriate location)
		OFF	Yes	Board not receiving power
	LD5	Green	No	Receiving proper voltage
		Dim green	Yes	Board not receiving data
		OFF	Yes	Board not receiving power

Location	LED #	State	Problem?	Description	
Main Board: CPU	LD4	Green	No	Board Receiving proper voltage	
		OFF	Yes	Board not receiving power	
	LD10	Orange	No	Receiving information via the module link	
		Dim flickering	Yes	Not receiving information via the module link	
	LED 11	Green	No	Receiving data	
		OFF	Yes, if data is applied	Not receiving data	
		Red	No	Transmitting data	
		OFF	Yes, if data is applied	Not transmitting data	
Main Board: 2-Phase Focus/ Zoom/ Iris	LD1	Green	No	Associated sensor is open	
		Yellow	No	Associated sensor is closed	
	LD2	Flashing red	No	Board is initializing	
	LD14	Infinitely flashing red	Yes	Board is not receiving data	
	LD15	Red	Yes	Board is not receiving data	
		OFF	Yes	Board is not receiving power	
Main Board: Pan	LD6	Red	No	Pan sensor open	
		Green	No	Pan sensor closed	
		Flashing red	Yes	Board not receiving data	
		OFF	Yes	Board not receiving data or power	
	LD7	Green	No	Board is programmed properly	
		Flashing red	Yes	Board is not programmed	
	Main Board: Tilt	LD8	Red	No	Tilt sensor open
			Green	No	Tilt sensor closed
Flashing red			Yes	Board is not receiving data	
OFF			Yes	Board is not receiving data or power	
LD9		Green	No	Board is programmed properly	
		Flashing red	Yes	Board is not programmed	
Data Com Board	Receive	Green	No	Receiving DMX data	
		OFF	Yes, if data is applied	Not receiving DMX data	
	Transmit	Red	No	Transmitting DMX data	
		OFF	Yes, if data is applied	Not transmitting DMX data	
LED Control Board	LD1	Flashing Red	Yes, if data is applied	Board not discovered	
		Off	No	Board is discovered	
	LD2	Green	No	Board Receiving data	
		Red	Yes, if data is applied	Board not receiving data	

Appendix A:

MSpeed Conversion Table

The following table lists the MSpeed (motor) movement times and their corresponding DMX controller values. If you have a numeric-type controller, use the Value Decimal (dec.) column. If you have a fader-type controller, use the Value Percentage (%) column. If your controller allows you to program hex values, use the Value (hex) column.

Time (sec.)	Value (dec.)	Value (%)	Value (hex)	Time (sec.)	Value (dec.)	Value (%)	Value (hex)	Time (sec.)	Value (dec.)	Value (%)	Value (hex)
0.15	255	100	FF	5.94	217	85	D9	23.30	179	70	B3
0.15	254	100	FE	6.25	216	85	D8	23.92	178	70	B2
0.17	253	99	FD	6.56	215	84	D7	24.54	177	69	B1
0.19	252	99	FC	6.89	214	84	D6	25.17	176	69	B0
0.21	251	98	FB	7.22	213	84	D5	25.80	175	69	AF
0.25	250	98	FA	7.56	212	83	D4	26.45	174	68	AE
0.29	249	98	F9	7.91	211	83	D3	27.10	173	68	AD
0.35	248	97	F8	8.27	210	82	D2	27.76	172	67	AC
0.41	247	97	F7	8.63	209	82	D1	28.43	171	67	AB
0.47	246	96	F6	9.00	208	82	D0	29.11	170	67	AA
0.55	245	96	F5	9.39	207	81	CF	29.80	169	66	A9
0.63	244	96	F4	9.77	206	81	CE	30.49	168	66	A8
0.73	243	95	F3	10.17	205	80	CD	31.19	167	65	A7
0.83	242	95	F2	10.58	204	80	CC	31.90	166	65	A6
0.94	241	95	F1	10.99	203	80	CB	32.62	165	65	A5
1.05	240	94	F0	11.41	202	79	CA	33.34	164	64	A4
1.18	239	94	EF	11.84	201	79	C9	34.08	163	64	A3
1.31	238	93	EE	12.28	200	78	C8	34.82	162	64	A2
1.45	237	93	ED	12.72	199	78	C7	35.57	161	63	A1
1.60	236	93	EC	13.17	198	78	C6	36.33	160	63	A0
1.75	235	92	EB	13.63	197	77	C5	37.09	159	62	9F
1.92	234	92	EA	14.10	196	77	C4	37.87	158	62	9E
2.09	233	91	E9	14.58	195	76	C3	38.65	157	62	9D
2.27	232	91	E8	15.07	194	76	C2	39.44	156	61	9C
2.46	231	91	E7	15.56	193	76	C1	39.44v	156	61	9C
2.66	230	90	E6	16.06	192	75	C0	40.23	155	61	9B
2.86	229	90	E5	16.57	191	75	BF	41.04	154	60	9A
3.07	228	89	E4	17.09	190	75	BE	41.85	153	60	99
3.29	227	89	E3	17.61	189	74	BD	42.68	152	60	98
3.52	226	89	E2	18.14	188	74	BC	43.50	151	59	97
3.76	225	88	E1	18.68	187	73	BB	44.34	150	59	96
4.00	224	88	E0	19.23	186	73	BA	45.19	149	58	95
4.25	223	87	DF	19.79	185	73	B9	46.04	148	58	94
4.52	222	87	DE	20.36	184	72	B8	46.90	147	58	93
4.78	221	87	DD	20.93	183	72	B7	47.77	146	57	92
5.06	220	86	DC	21.51	182	71	B6	48.65	145	57	91
5.34	219	86	DB	22.10	181	71	B5	49.54	144	56	90
5.64	218	85	DA	22.70	180	71	B4	50.43	143	56	8F

Time (sec.)	Value (dec.)	Value (%)	Value (hex)	Time (sec.)	Value (dec.)	Value (%)	Value (hex)	Time (sec.)	Value (dec.)	Value (%)	Value (hex)
51.33	142	56	8E	102.77	95	37	5F	175.24	46	18	2E
52.24	141	55	8D	104.05	94	37	5E	176.92	45	18	2D
53.16	140	55	8C	105.35	93	36	5D	178.61	44	17	2C
54.09	139	55	8H	106.65	92	36	5C	180.30	43	17	2B
55.02	138	54	8A	107.96	91	36	5B	182.01	42	16	2A
55.96v	137	54	89	109.28	90	35	5A	183.72	41	16	29
56.91	136	53	88	110.61	89	35	59	185.44	40	16	28
57.87	135	53	87	111.94	88	35	58	187.17	39	15	27
58.84	134	53	86	113.28	87	34	57	188.90	38	15	26
59.81	133	52	85	114.63	86	34	56	190.65	37	15	25
60.79	132	52	84	115.99	85	33	55	192.40	36	14	24
61.78	131	51	83	117.36	84	33	54	194.16	35	14	23
62.78	130	51	82	118.73	83	33	53	195.92	34	13	22
63.79	129	51	81	120.12	82	32	52	197.70	33	13	21
64.80	128	50	80	121.5v	81	32	51	199.48	32	13	20
65.82	127	50	7F	122.91	80	31	50	201.28	31	12	1F
66.85	126	49	7E	124.31	79	31	4F	203.08	30	12	1E
67.89	125	49	7D	125.73	78	31	4E	204.88	29	11	1D
68.94	124	49	7C	127.15	77	30	4D	206.70	28	11	1C
69.99	123	48	7B	128.58	76	30	4C	208.52	27	11	1B
71.05	122	48	7A	130.02	75	29	4B	210.36	26	10	1A
72.13	121	47	79	134.39	72	28	48	212.19	25	10	19
73.20	120	47	78	135.86	71	28	47	214.04	24	9	18
74.29	119	47	77	137.34	70	27	46	215.90	23	9	17
75.38	118	46	76	138.82	69	27	45	217.76	22	9	16
76.49	117	46	75	140.32	68	27	44	219.63	21	8	15
77.60	116	45	74	141.82	67	26	43	221.51	20	8	14
78.71	115	45	73	143.33	66	26	42	223.40	19	7	13
79.84	114	45	72	144.85	65	25	41	225.30	18	7	12
80.98	113	44	71	146.38	64	25	40	227.20	17	7	11
82.12	112	44	70	147.92	63	25	3F	229.11	16	6	10
83.27	111	44	6F	149.46	62	24	3E	231.03	15	6	0F
84.43	110	43	6E	151.01	61	24	3D	232.96	14	5	0E
85.59	109	43	6D	152.57	60	24	3C	234.90	13	5	0D
86.77	108	42	6C	154.14	59	23	3B	236.84	12	5	0C
87.95	107	42	6B	155.71	58	23	3A	238.79	11	4	0B
89.14	106	42	6A	157.30	57	22	39	240.75	10	4	0A
90.34	105	41	69	158.89	56	22	38	242.72	9	4	09
91.55	104	41	68	160.49	55	22	37	244.70	8	3	08
92.76	103	40	67	162.09	54	21	36	246.68	7	3	07
93.98	102	40	66	163.71	53	21	35	248.68	6	2	06
95.21	101	40	65	165.33	52	20	34	250.68	5	2	05
96.45	100	39	64	166.96	51	20	33	246.68	7	3	07
97.70	99	39	63	168.60	50	20	32	248.68	6	2	06
98.95	98	38	62	170.25	49	19	31	250.68	5	2	05
100.22	97	38	61	171.91	48	19	30	252.68	4	2	04
101.49	96	38	60	173.57	47	18	2F				

Appendix B:

Important Safety Information

Warning: For Continued Protection Against Fire

1. This equipment is designed for use with specified lamps only. Use of any other type lamp may be hazardous and may void the warranty.
2. Do not mount on a flammable surface.
3. Maintain minimum distance of 6.0 meter (19.7 feet) from combustible materials.
4. Replace fuses only with the specified type and rating.
5. Observe minimum distance to lighted objects of 4.0 meter (13 feet).
6. This equipment for connection to branch circuit having a maximum overload protection of 20 A.

Warning: For Continued Protection Against Electric Shock

1. If this equipment was received without a line cord plug, attach the appropriate line cord plug according to the following code:
 - brown–live
 - blue–neutral
 - green/yellow–earth
2. In the United Kingdom, the colours of the cores in the mains lead of this equipment may not correspond with the coloured markings identifying the terminals in your plug, proceed as follows:
 - the core which is coloured green and yellow must be connected to the terminal in the plug which is marked with the letter E or by the earth symbol , or coloured green or green and yellow.
 - the core which is coloured blue must be connected to the terminal which is marked with the letter N or coloured black.
 - the core which is coloured brown must be connected to the terminal which is marked with the letter L or coloured red.
3. Class I equipment. This equipment must be earthed.
4. Equipment suitable for dry locations only. Do not expose this equipment to rain or moisture.
5. Disconnect power before re-lamping or servicing.
6. Refer servicing to qualified personnel; no user serviceable parts inside.

Warning: For Continued Protection Against Exposure To Excessive Ultraviolet (UV) Radiation

1. Change shields and lenses if they have become visibly damaged to such an extent that their effectiveness is impaired, for example by cracks or deep scratches.
2. Never look directly at the lamp while lamp is on.

Warning: For Continued Protection Against Injury To Persons

1. Use secondary safety cable when mounting this fixture.
2. Caution: Hot lamp may be an explosion hazard. Do not open for 5 minutes after switching off. Wear eye and hand protection when re-lamping.
3. Equipment surfaces may reach temperatures up to 160° C (320° F). Allow a minimum of 10 minutes for cooling before handling.
4. Change the lamp if it becomes damaged or thermally deformed.

Appendice B: Importantes Informations Sur La Sécurité

Mise En Garde: Pour Une Protection Permanente Contre Les Incendies

1. Cet appareil est conçu pour l'usage avec les lampes spécifiées seulement. Son utilisation avec tout autre type de lampe peut être dangereuse et annuler la garantie.
2. Ne pas monter les lampes sur une surface inflammable.
3. Maintenir à une distance minimum de 6.0 mètre de matières inflammables.
4. Ne remplacer les fusibles qu'avec des modèles et valeurs assignées recommandés.
5. Respecter une distance minimum de 4.0 mètre par rapport aux objets éclairés.
6. Cet appareil de connection au circuit comporte une protection contre les surcharges de 20 A.

Mise En Garde: Pour Une Protection Permanente Contre Les Chocs Électriques

1. Si cet équipement est livré sans prise de cable, veuillez connecter la prise de cable correcte selon le code suivant:
 - marron - phase
 - bleu - neutre
 - vert/jaune - terre
2. Débrancher le courant avant de changer les lampes ou d'effectuer des réparations.
3. Cet équipement doit être uniquement utilisé dans des endroits secs. Ne pas l'exposer à la pluie ou l'humidité.
4. À l'intérieur de l'équipement il n'y a pas de pièces remplaçables par l'utilisateur. Confiez l'entretien à un personnel qualifié.
5. Equipement de Classe I. Cet équipement doit être mis à la terre.

Mise En Garde: Pour Une Protection Permanente Contre Des Expositions Excessives Aux Rayons Ultra Violets (UV)

1. Changer les blindages ou les écrans s'ils sont visiblement endommagés au point que leur efficacité aient été altérée, par exemple par des fissures ou de profondes égratignures.
2. Ne jamais regarder directement la lampe quand celle ci est allumée.

Mise En Garde: Pour Une Protection Permanente Contre Les Blessures Corporelles

1. Lors de l'assemblage, utiliser un câble de sécurité secondaire.
2. AVERTISSEMENT: Les lampes chaudes comportent un risque d'explosion. Après l'avoir éteinte, attendre 5 minutes avant de la dégager. Lors du remplacement de la lampe, une protection des yeux et des mains est requise.
3. Les surfaces de l'appareil peuvent atteindre des températures de 160 C. Laisser refroidir pendant 5 minutes avant la manipulation.
4. Changer la lampe si elle est endommagée ou thermiquement déformée.

Anhang B: Wichtige Hinweise Für Ihre Sicherheit

Warnung: Zum Schutz Vor Brandgefahr

1. Diese Ausrüstungen sind für Gebrauch mit angegebenen Lampen nur entworfen. Der Gebrauch irgend eines anderen Lampentyps könnte Sie gefährden und Ihre Garantie außer Kraft setzen.
2. Das Gerät nie auf einer feuergefährlichen Fläche montieren.
3. Stets einen Mindestabstand von 6 Meter zu brennbaren Materialien einhalten.
4. Zum Ersatz nur Sicherungen verwenden, die dem vorgeschriebenen Typ und Nennwert entsprechen.
5. Einen Mindestabstand von 4 Meter zu den angestrahlten Objekten einhalten.
6. Dieses Gerät darf nur an eine Zweigleitung mit einem Überlastungsschutz von höchstens 20 A angeschlossen werden.

Warnung: Zum Schutz Gegen Gefährliche Körperströme

1. Wenn dieses Gerät ohne einen Netzkabelstecker erhalten wurde, ist der entsprechende Netzkabelstecker entsprechend dem folgenden Code anzubringen:
 - Braun - Unter Spannung stehend
 - Blau - Neutral
 - Grün/Gelb - Erde
2. Vor dem Austauschen von Lampen oder vor Wartungsarbeiten stets den Netzstecker ziehen.
3. Diese Geräte sind nur zum Einbau in trockenen Lagen bestimmt und müssen vor Regen und Feuchtigkeit geschützt werden.
4. Servicearbeiten sollten nur von Fachpersonal ausgeführt werden. Das Gerät enthält keine wartungsbedürftigen Teile.
5. Dieses Gerät gehört zur Klasse I. Dieses Gerät muß geerdet werden.

Warnung: Zum Schutz Gegen Übermäßige Ultraviolett (UV)-Bestrahlung

1. Die Schutzabdeckungen, Linsen und der UV-Schutz müssen ausgewechselt werden, wenn sie sichtlich dermaßen beschädigt sind, daß sie ihre Wirksamkeit einbüßen, z.B. infolge von Rissen oder tiefen Kratzern.
2. Nie direkt in die eingeschaltete Lampe schauen.

Warnung: Zum Schutz Vor Verletzungen

1. Verwenden Sie bei der Installation des Beleuchtungskörpers ein zusätzliches Sicherheitskabel.
2. VORSICHT: Bei einer heißen Lampe besteht Explosionsgefahr. Nach dem Abschalten der Netzspannung sollten Sie etwa 5 Minuten warten, bevor Sie das Lampengehäuse öffnen. Schützen Sie beim Auswechseln der Lampen Ihre Hände und tragen Sie eine Schutzbrille.
3. Die Oberflächen des Gerätes können Temperaturen bis zu 160 C erreichen. Vor dem Anfassen stets 5 Minuten lang abkühlen lassen.
4. Falls die Lampe beschädigt oder durch Wärmeeinwirkung verformt ist, muß sie ausgewechselt werden.

Apéndice B: Información Importante De Seguridad

Advertencia: Para Protección Continua Contra Incendios

1. Este equipo se diseña para el uso con lámparas especificadas sólo. El uso de cualquier otro tipo de lámpara podrá resultar peligroso, y podrá anular la garantía.
2. No monte el equipo sobre una superficie inflamable.
3. Mantenga una distancia mínima de materiales combustibles de 6.0 metro.
4. Cambie los fusibles únicamente por otros que sean del tipo y la clasificación especificadas.
5. Guarda una distancia mínima a objetos iluminados de 4,0 metro.
6. Este equipo debe conectarse a un circuito que tenga una protección máxima contra las sobrecargas de 20 A.

Advertencia: Para La Protección Continua Contra Electrocuiones

1. Si se recibió este equipo sin el enchufe de alimentación, monte usted el enchufe correcto según el clave siguiente:
 - moreno - vivo
 - azul - neutral
 - verde/amarillo - tierra
2. Desconecte el suministro de energía antes de recambiar lámparas o prestar servicio de reparación.
3. Questa apparecchiatura e' da usarsi in ambienti secchi. Non e' da essere esposta ne alla pioggia ne all' umidita'.
4. Derive el servicio de reparación de este equipo al personal calificado. El interior no contiene repuestos que puedan ser reparados por el usuario.
5. Equipo de Clase I. Este equipo debe conectarse a la tierra.

Advertencia: Para Protección Continua Contra La Exposición A Radiación Ultravioleta (UV) Excesiva

1. Cambie el blindaje, los lentes si nota una avería visible, a tal grado que su eficacia se vea comprometida. Por ejemplo, en el caso de grietas o rayaduras profundas.
2. Jamás mire directamente a la lámpara en tanto ésta esté encendida.

Advertencia: Para Protección Continua Contra Lesiones Corporales

1. Al montare questa apparecchiatura, usare un secondo cavo di sicurezza.
2. Precaución: Una lámpara caliente puede constituir un peligro de explosión. No la abra por 5 minutos luego de haberla apagado. Lleve puestos, un protector ocular, y guantes al recambiar lámparas.
3. Las superficies del equipo pueden alcanzar temperaturas máximas de 160 grados centígrados. Deje que se enfríen por 5 minutos antes de tocarlas.
4. Cambie la lámpara si ésta se avería o deforma por acción térmica.

Appendice B: Importanti Informazioni Di Sicurezza

Avvertenza: Per Prevenire Incendi

1. Quest'apparecchiatura è disegnata per l'uso con le lampade specificate soltanto. L'uso di qualunque altra lampada di tipo può essere pericoloso e può nullo la garanzia.
2. Da non montare sopra una superficie infiammabile.
3. Mantenere l' apparecchio a un minimo di 6.0 metri (3.28 piedi) di distanza dai materiali combustibili.
4. Rimpiazzare i fusibili usando soltanto quelli del tipo e della taratura adatta.
5. Mantenere una distanza minima di 4.0 metri (6.56 piedi) dagli oggetti accesi.
6. Questa apparecchiatura e' da collegarsi ad un circuito con una protezione da sovraccarico massima di 20 amperes.

Avvertenza: Per Prevenire Le Scosse Elettriche

1. Se questa apparecchiatura è stata consegnata senza una spina del cavo di alimentazione, collegare la spina appropriata del cavo di alimentazione in base ai seguenti codici:
 - marrone - sotto tensione
 - blu - neutro
 - verde/giallo - terra
2. Disinnestare la corrente prima di cambiare la lampadina o prima di eseguire qualsiasi riparazione.
3. Este equipo se adecua a lugares secos solamente. no lo exponga a la lluvia o humedad.
4. Per qualsiasi riparazione rivolgersi al personale specializzato. L' utente non deve riparare nessuna parte dentro l' unita'.
5. Aparecchio di Classe I. Questa apparecchiatura deve essere messa a terra.

Avvertenza: Per Proteggersi Contro Le Radiazioni Dei Raggi Ultravioletti

Non usare questa apparecchiatura se il sistema di chiusura della lampadina non e' completo o se gli scudetti, le lenti, si sono visibilmente danneggiati di maniera tale che la loro efficacia sia stata ridotta --- ad esempio, se vi sono visibili spaccature o graffi profondi. Mai guardare direttamente verso la lampadina quando sia accesa.



Avvertenza: Per Non Ferire Ad Altre Persone

1. Use cable secundario de seguridad al montar este aparato.
2. Avvertenza: La lampadina calda potrebbe esplodere. Spegnerla per 5 minuti prima di aprirla. Usare protezioni per le mani e per gli occhi prima di cambiare la lampadina.
3. Le superfici della apparecchiatura possono arrivare a temperature di 160 gradi centigradi (194 gradi f). Aspettare 5 minuti prima di maneggiare.
4. Cambiare la lampadina se si danneggia o se si e' deformata dovuto alle alte temperature.

Vigtig Sikkerhedsinformation

Advarsel: Beskyttelse mod elektrisk chock.

VIGTIGT!

LEDEREN MED GUL/GROEN ISOLATION MAA KUN TILSLUTTES KLEMME MAERKET 
ELLER .

